







# CHOOSE WHAT YOU WANT TO BUILD FIRST! CHOISISSEZ CE QUE VOUS VOULEZ CONSTRUIRE EN PREMIER!

¡ELIGE QUÉ QUIERES CONSTRUIR PRIMERO! • ESCOLHA O QUE VOCÊ QUER CONSTRUIR PRIMEIRO! KINDER KÖNNEN AUSSUCHEN, WAS SIE ZUERST BAUEN WOLLEN! • ВЫБЕРИ, ЧТО ТЫ ХОЧЕШЬ СОБРАТЬ СНАЧАЛА!

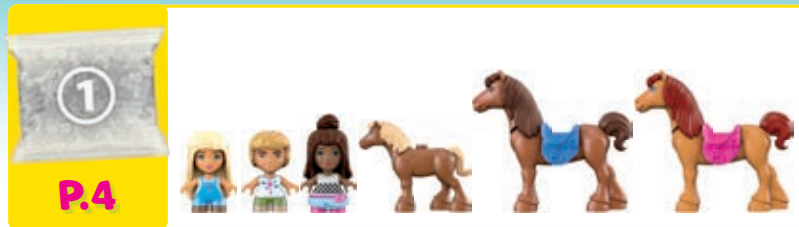

MEGA  
UNBOXED

## Build Construisez

Construye | Constrói  
Bauen | Стройте



## Share Partagez

Comparte | Partilha  
Teilen | Делитесь

Devices not included | Appareils non inclus  
Dispositivos no incluído | Dispositivos não incluídos  
Geräte nicht enthalten | Устройства не входят в комплект

## Play as you build! Jouez en construisant!

Juega mientras  
construyes!  
Construção e  
brincadeira  
simultâneas!  
Gleichzeitig  
bauen  
und spielen!  
Строй и играй!



unboxed.megaconstrux.com





# CUSTOMIZE YOUR BARBIE FIGURE! PERSONNALISEZ VOTRE FIGURINE BARBIE!

PERSONALIZA TU BARBIE! • PERSONALIZE SUA BARBIE!  
DIE BARBIE-FIGUREN INDIVIDUELL GESTALTEN! • СДЕЛАЙ СВОЮ ФИГУРКУ БАРБИ УНИКАЛЬНОЙ!



1



2



1



2







1



2



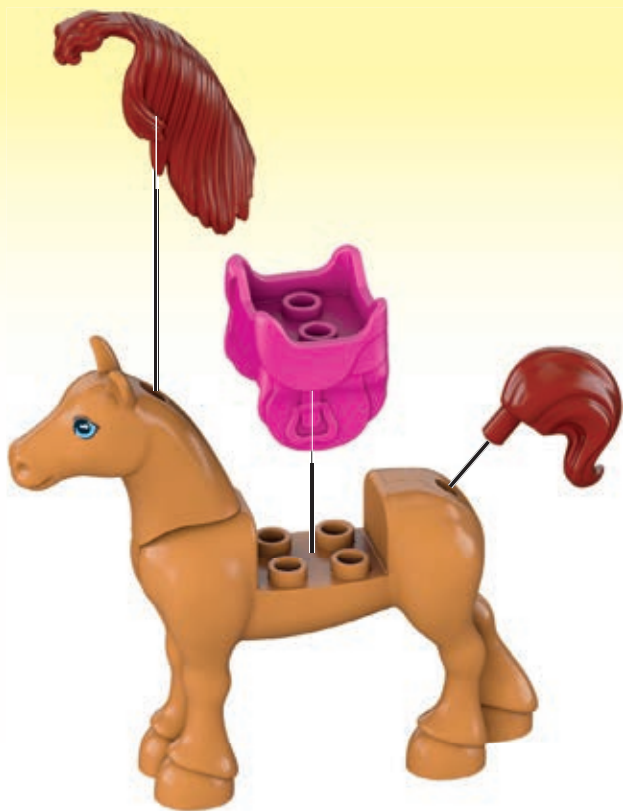

1



2

# LET'S BUILD THE BARN! CONSTRUYAMOS LA GRANGE!

¡CONSTRUYAMOS EL GRANERO!  
CONSTRUAMOS O CELEIRO!  
EINE SCHEUNE BAUEN!  
ПОСТРОИМ КОНЮШНЮ!

2

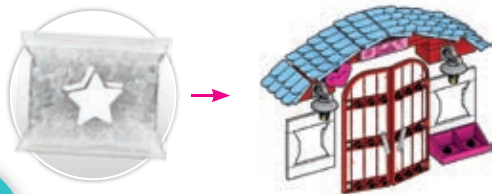
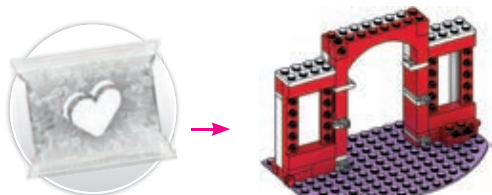

## Building Tool Outil de construction

Herramienta de construcción  
Bauwerkzeug  
Ferramenta de montagem  
Инструмент для конструирования

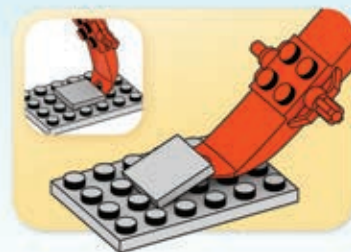





**1**

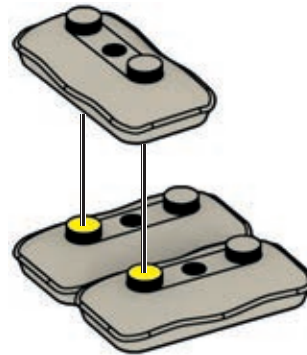

**1**



**2**

2

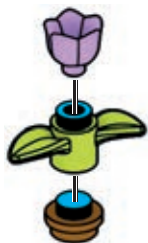

1



2

3



1



2



4

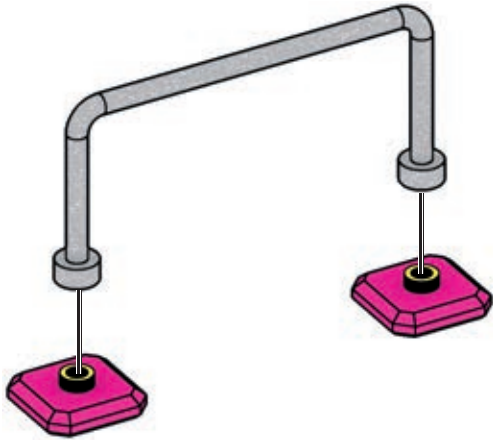
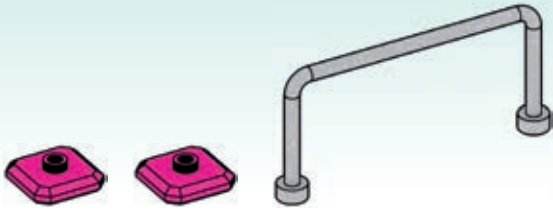

5

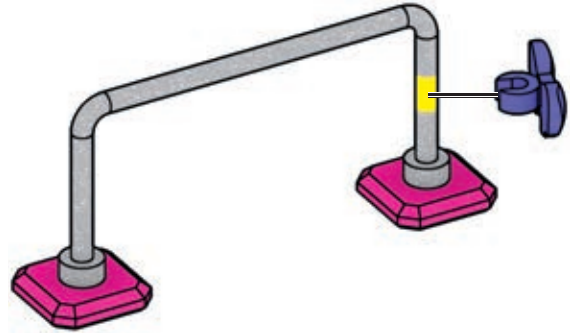

6

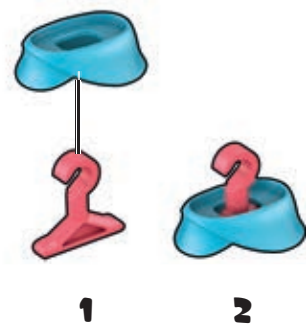
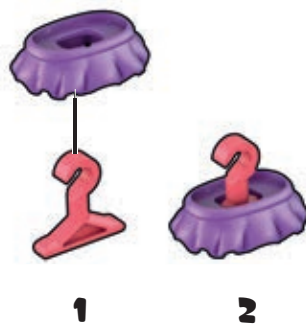
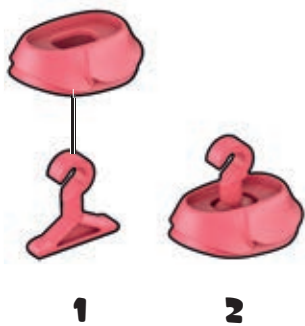

7

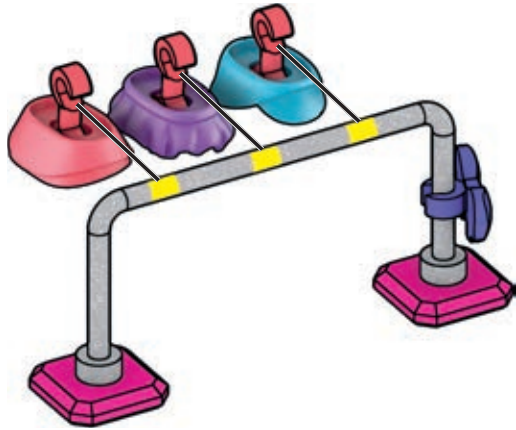

1



2



8

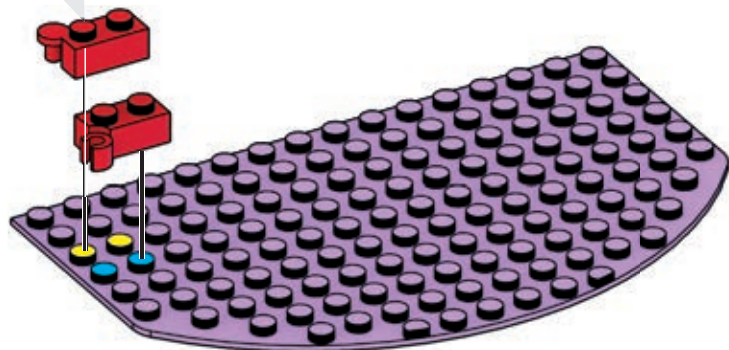
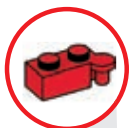
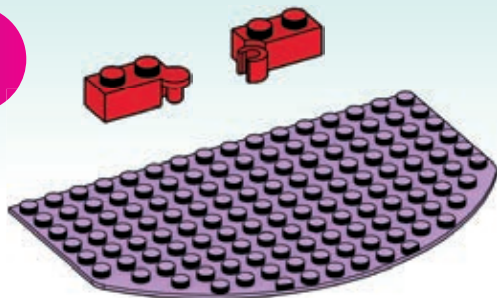

9

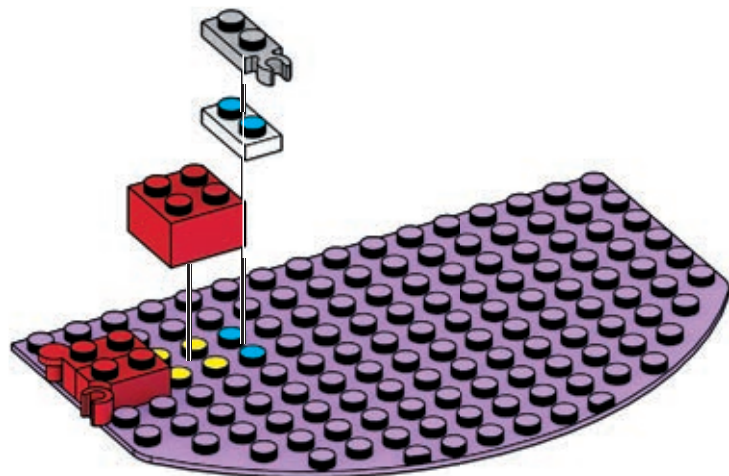



10

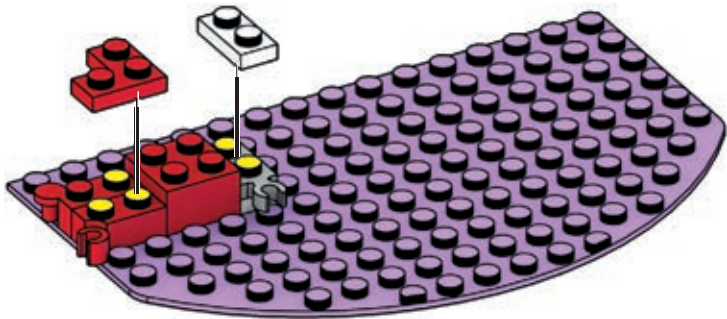

11

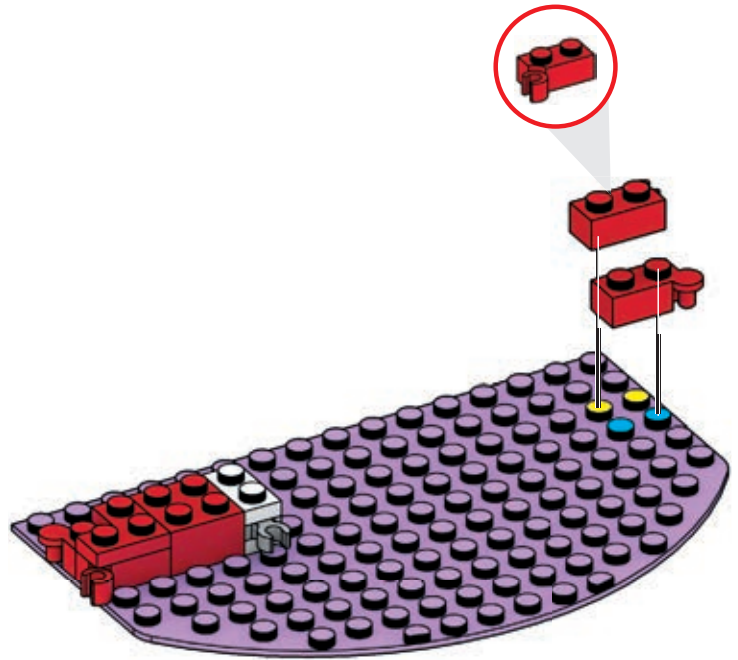

12

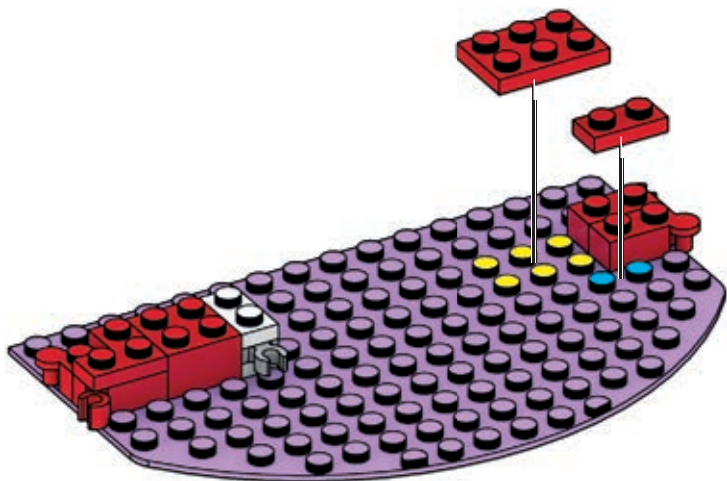

13

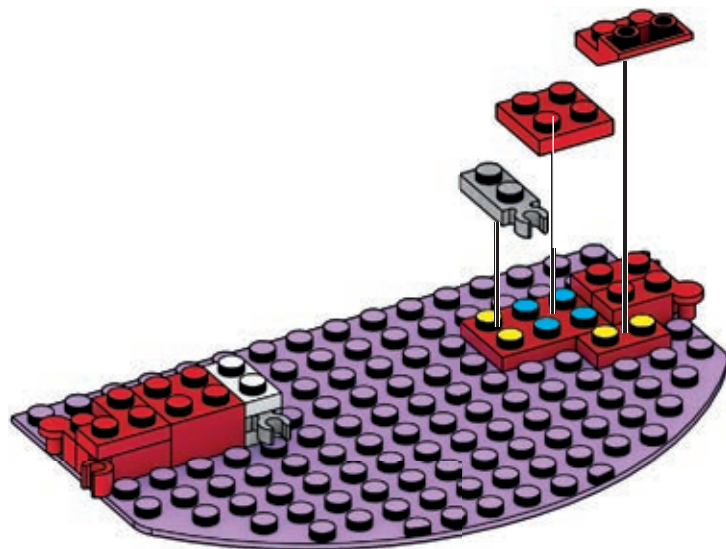

14

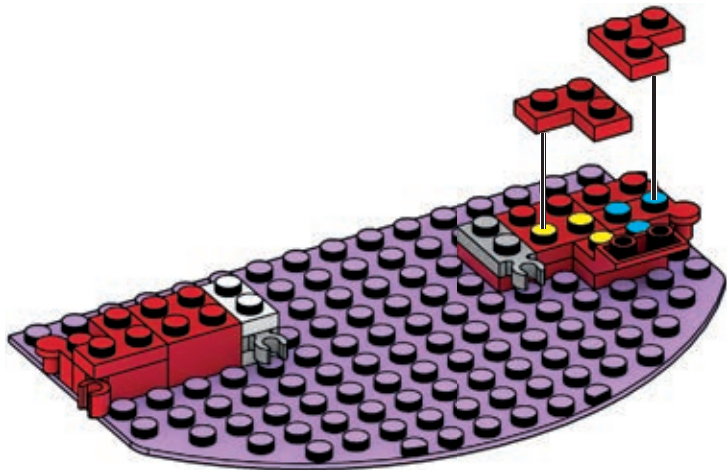

15

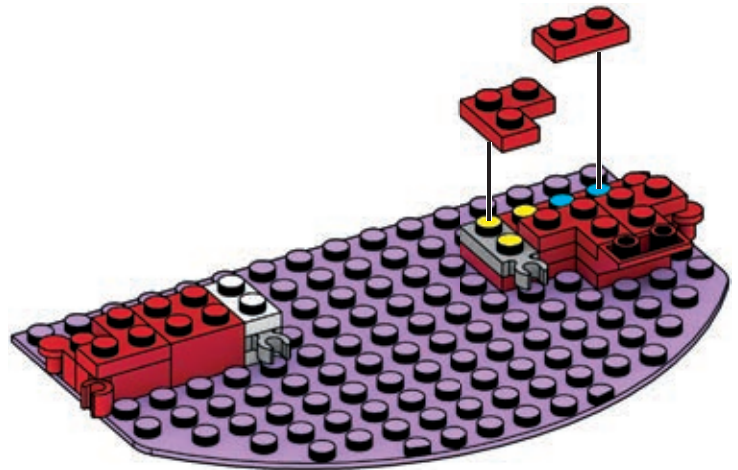

16

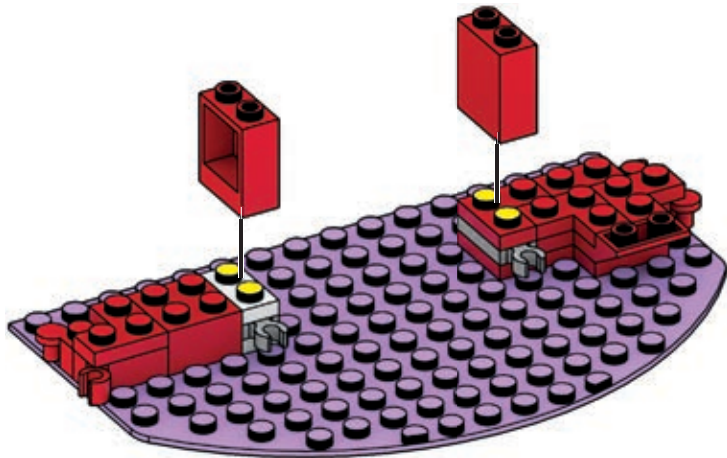

17

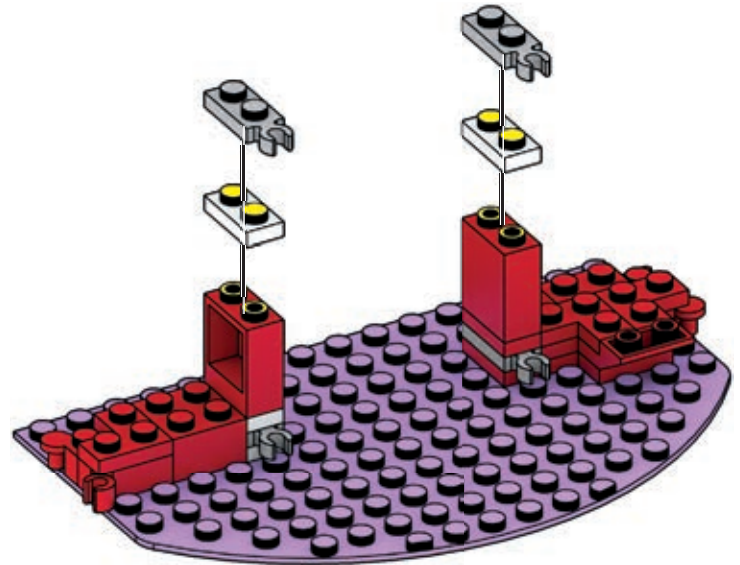
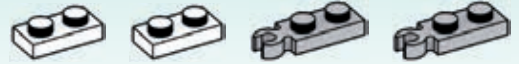



18

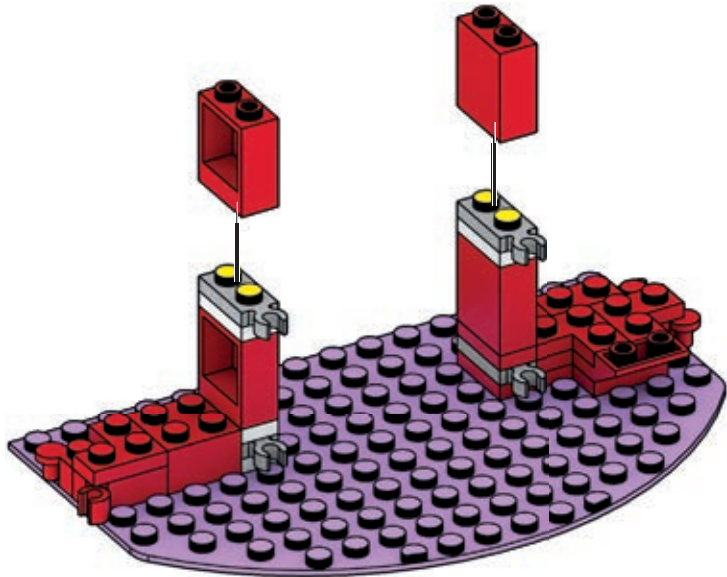
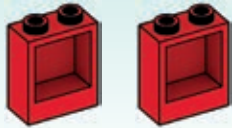

19

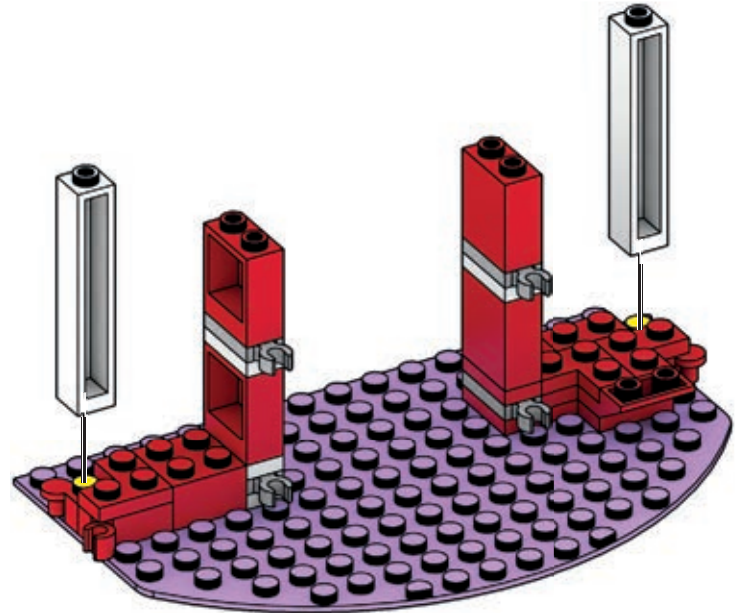
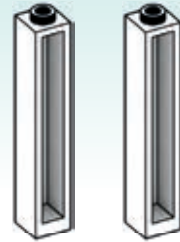



22

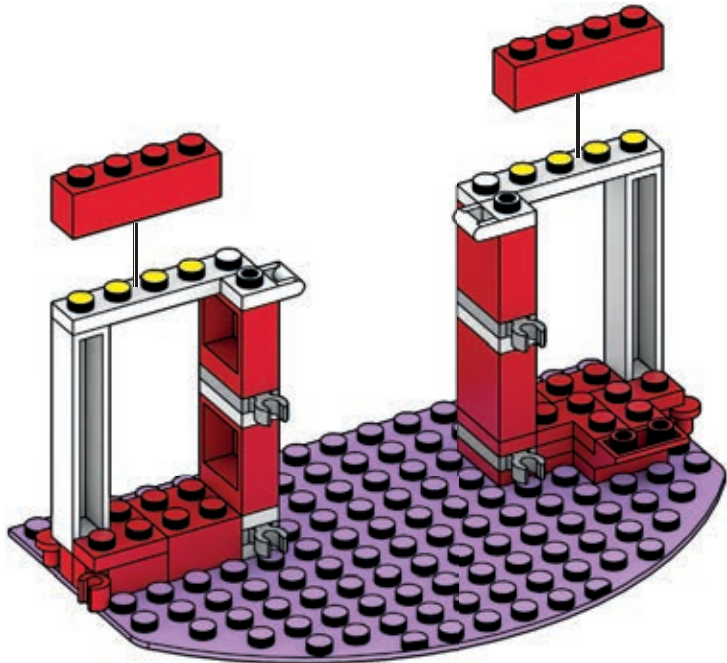
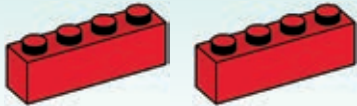

23

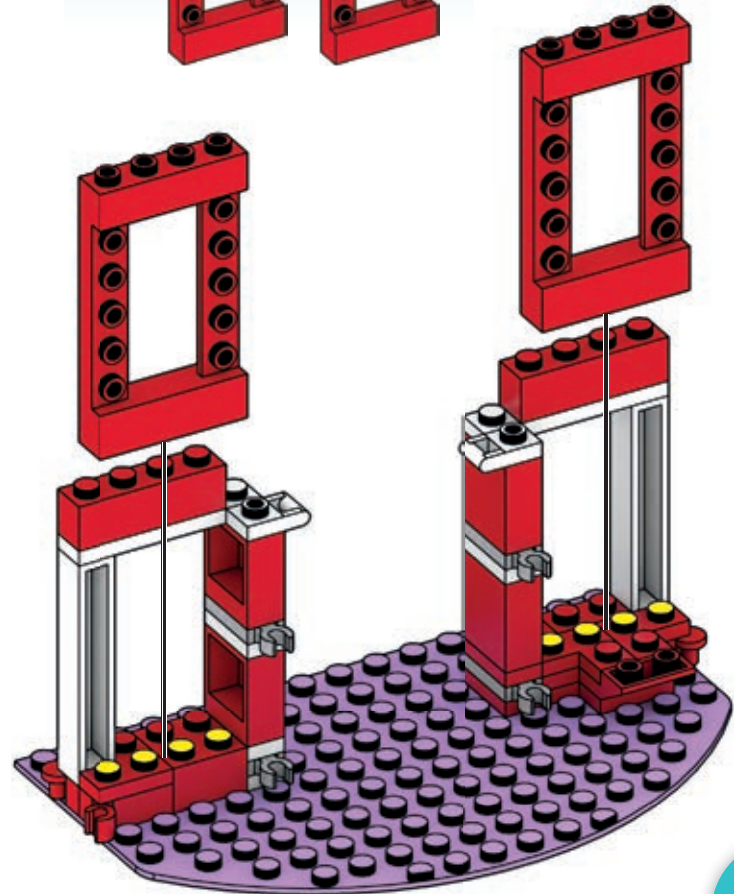
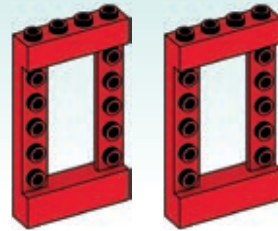

24

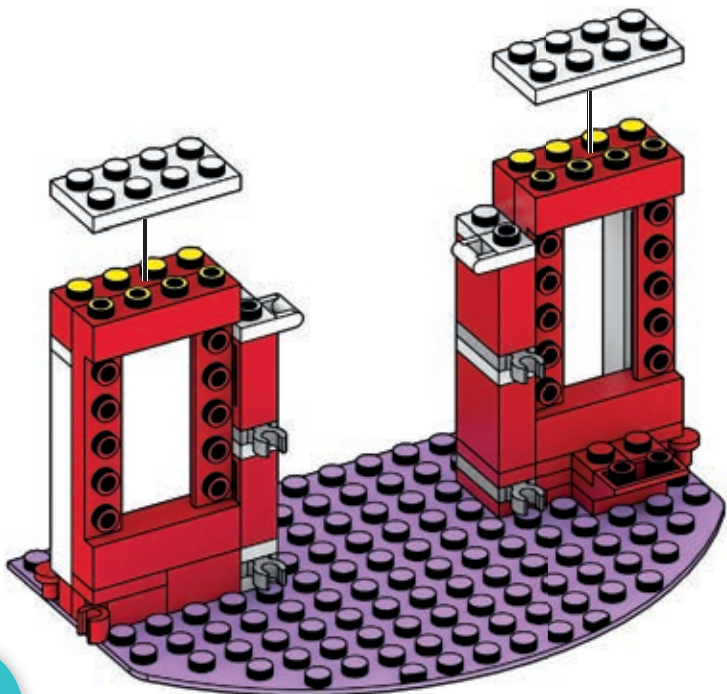

25

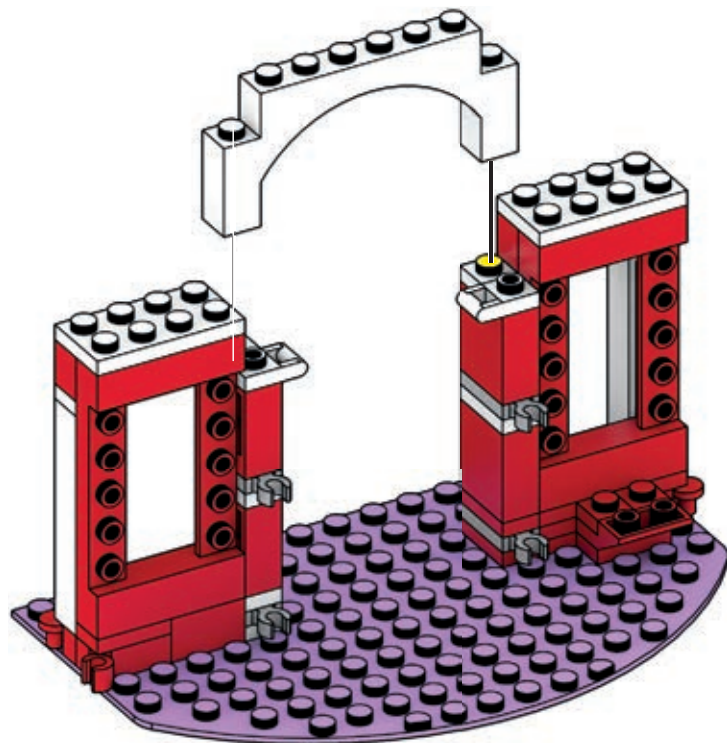
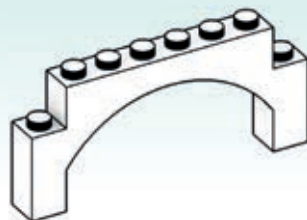



26

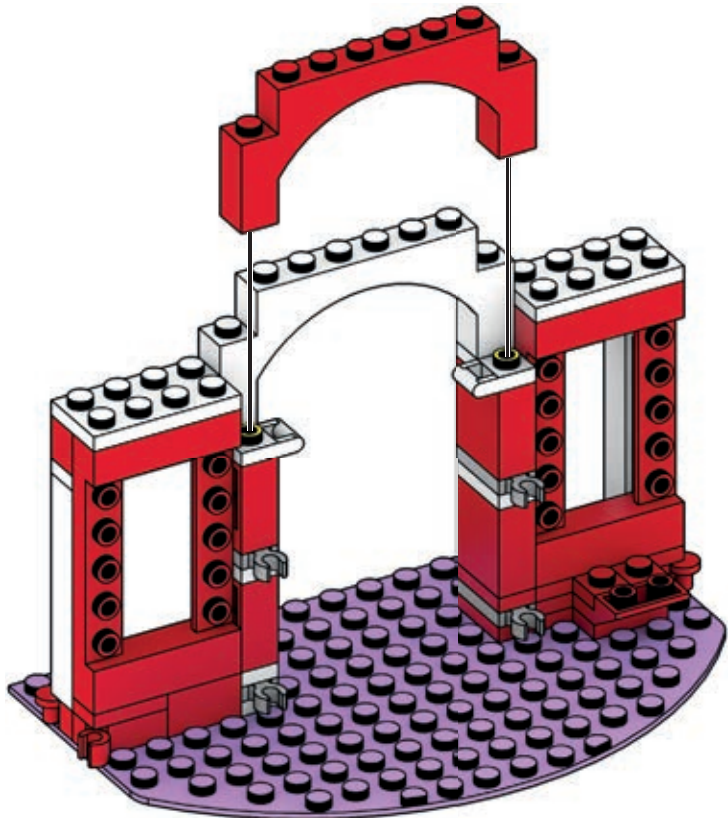
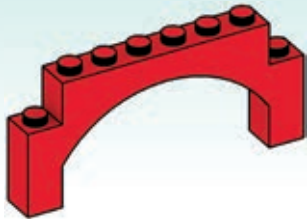

27

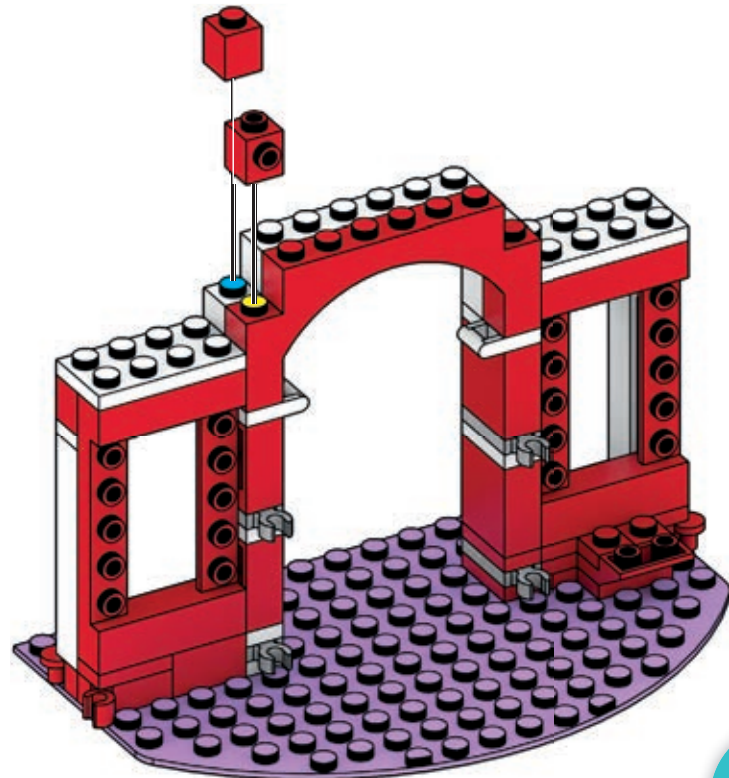

28

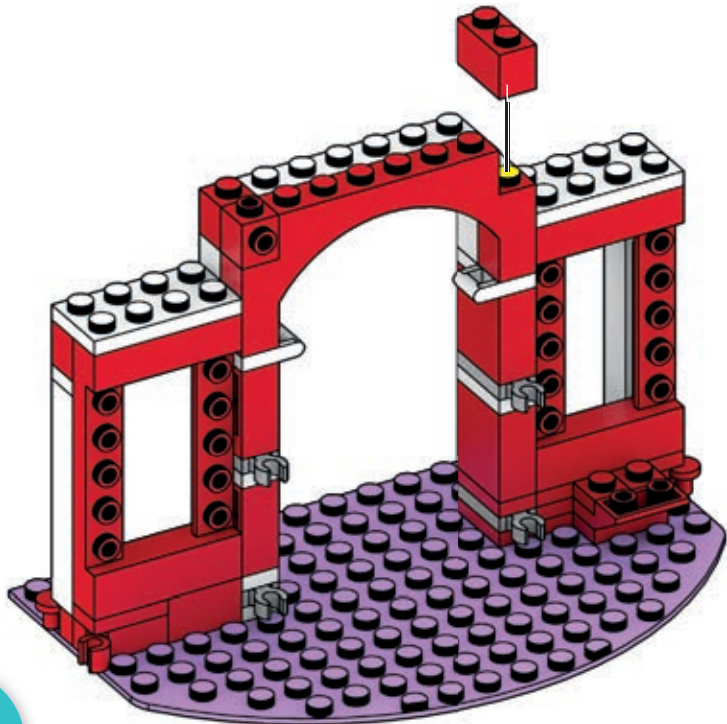

29

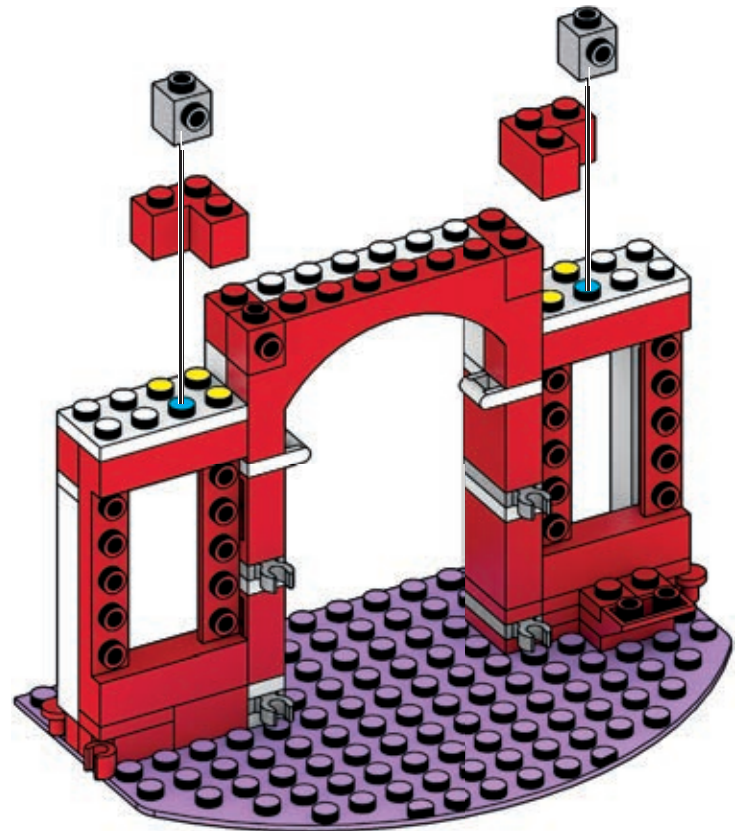

30

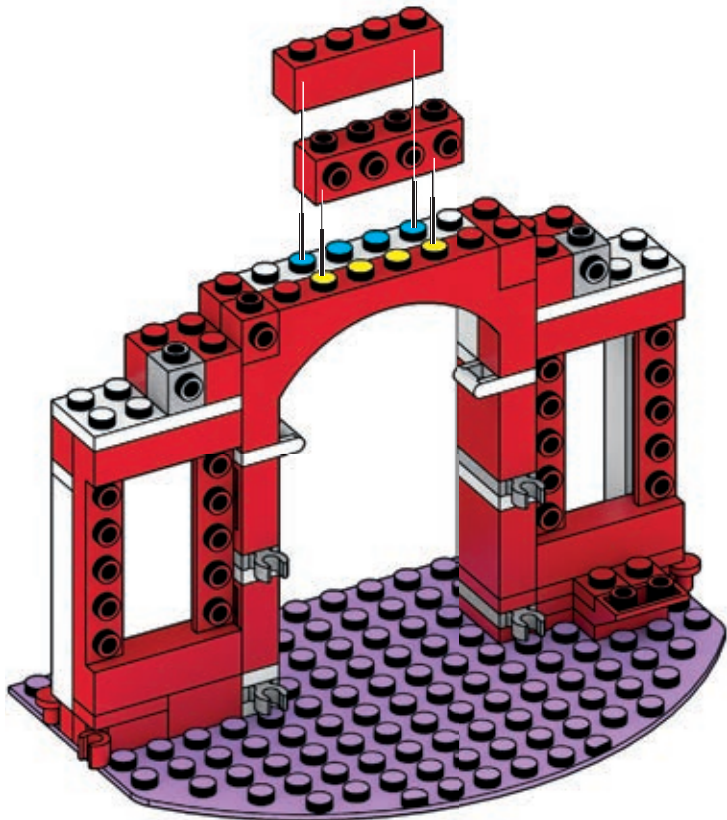
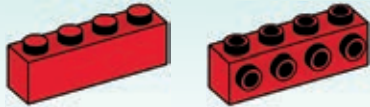

31

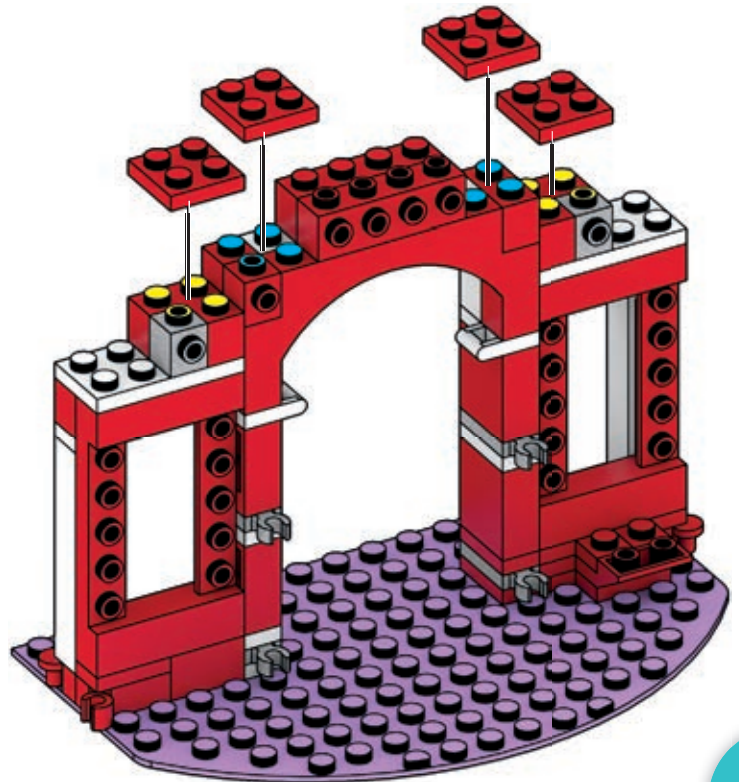



32

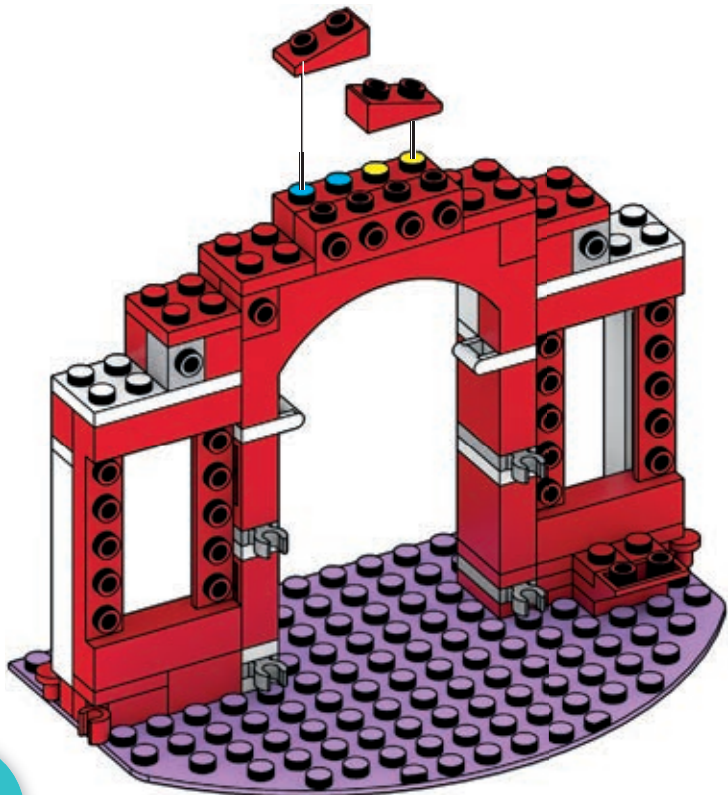

33

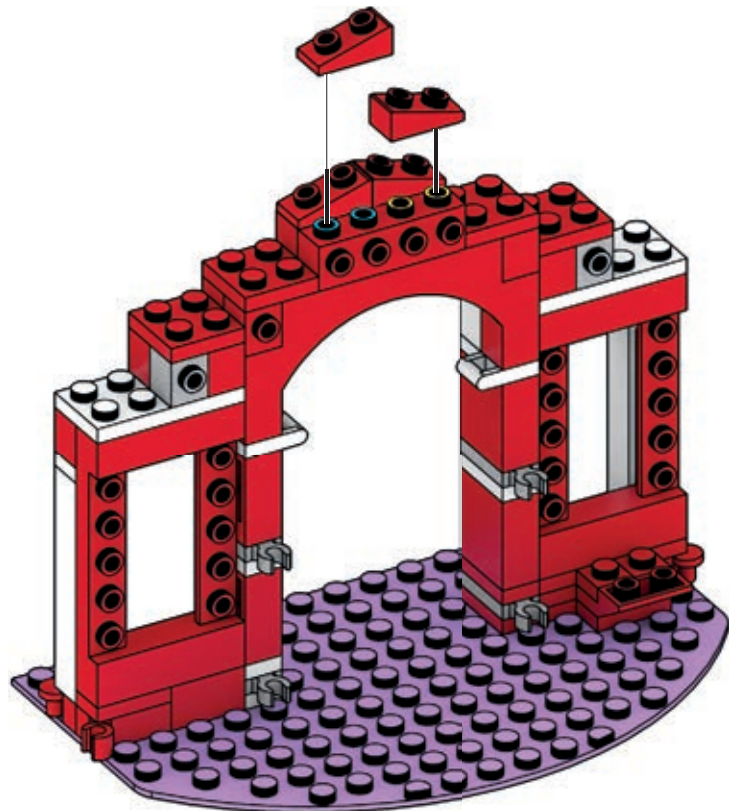



34

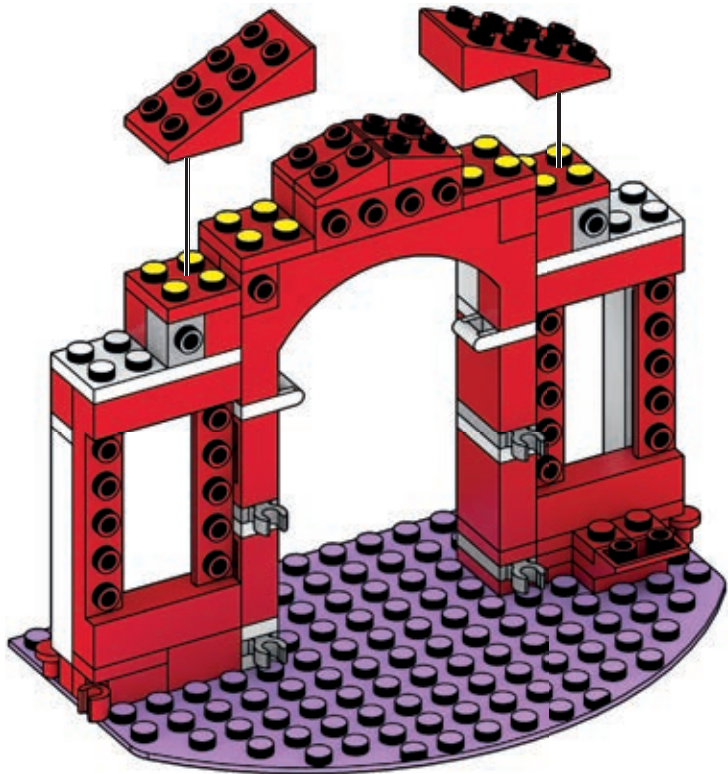
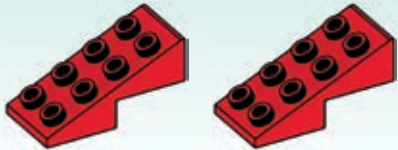

35

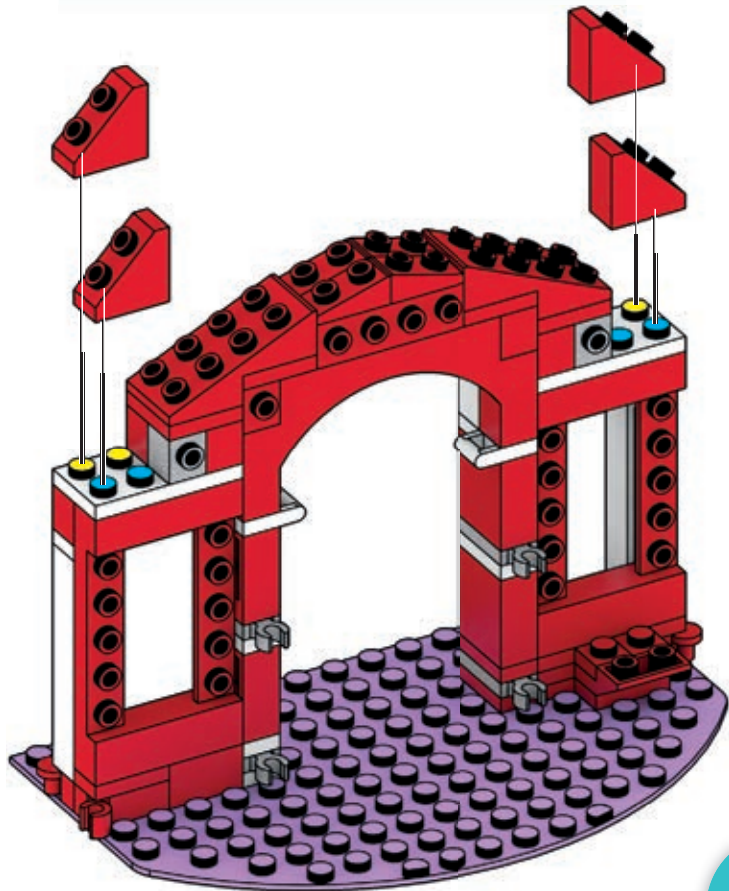
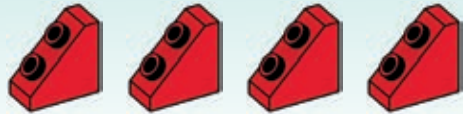

36

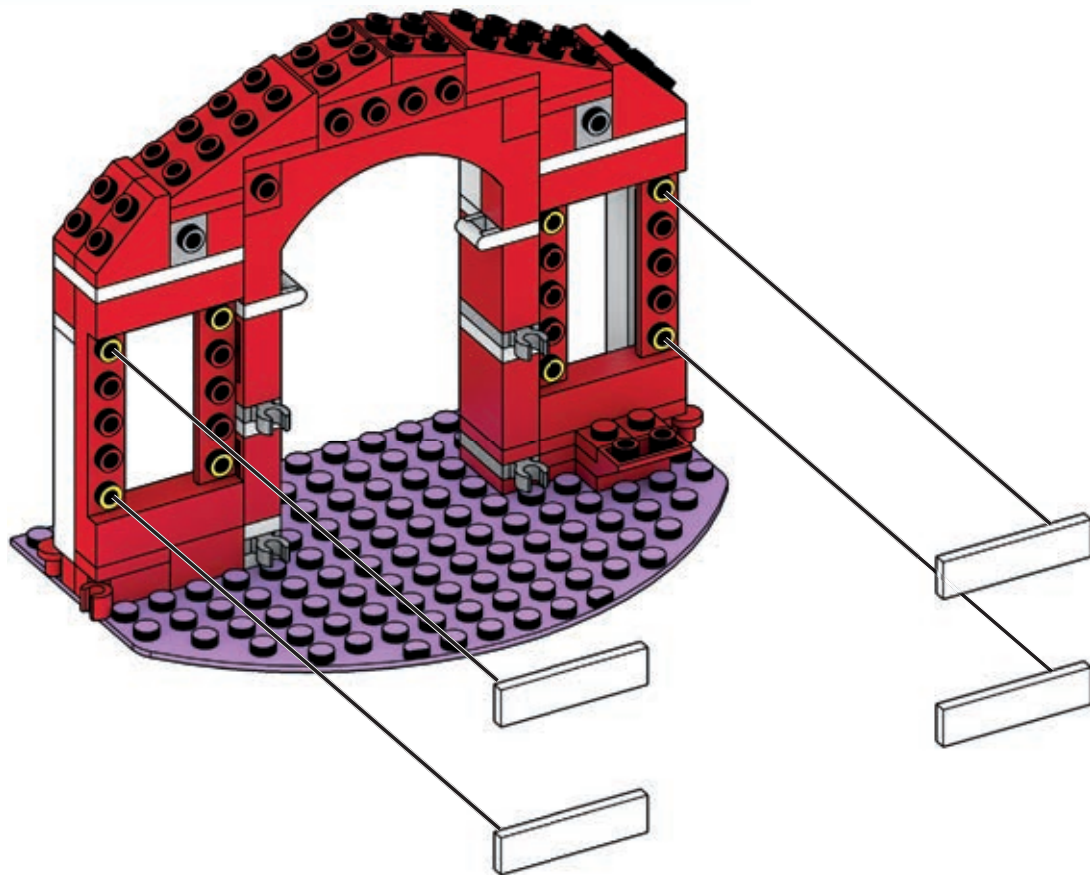

37

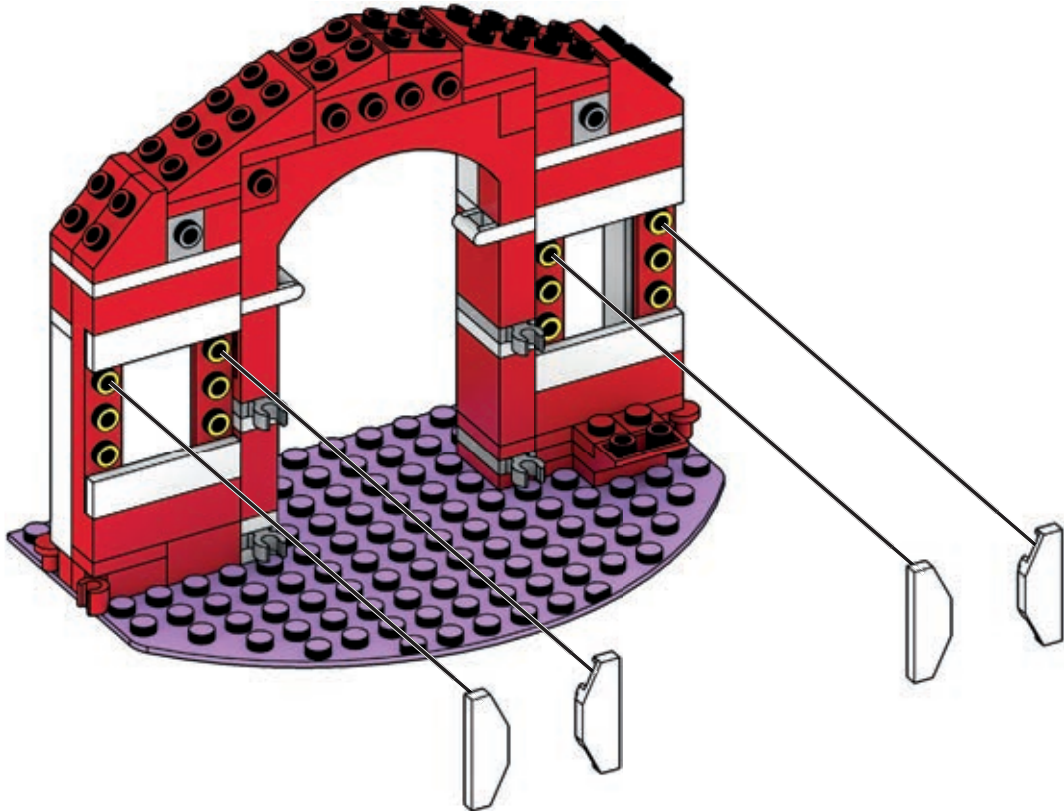

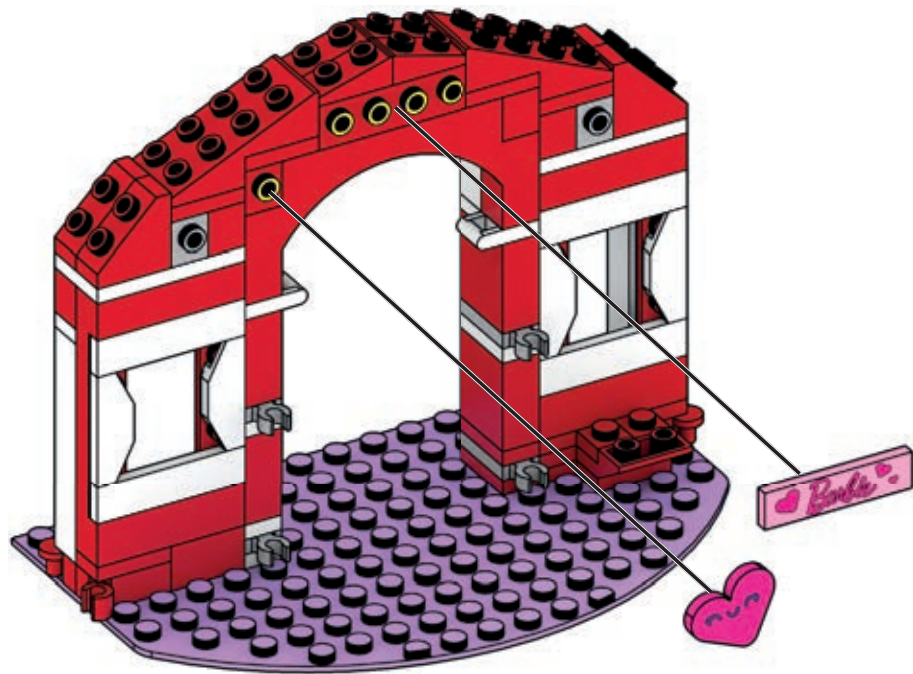

39

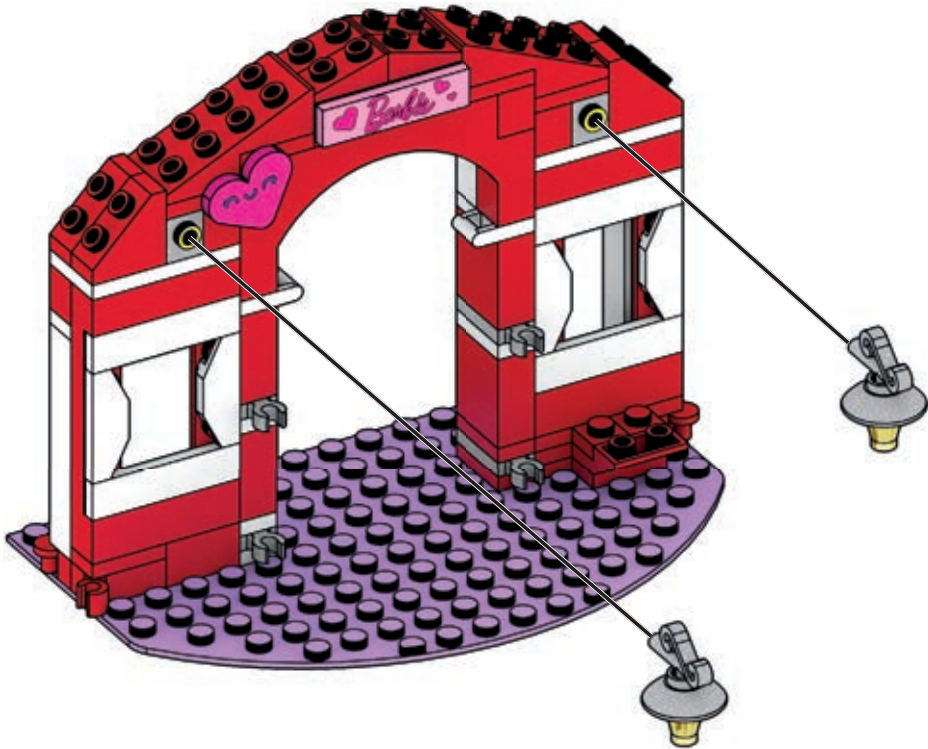



40

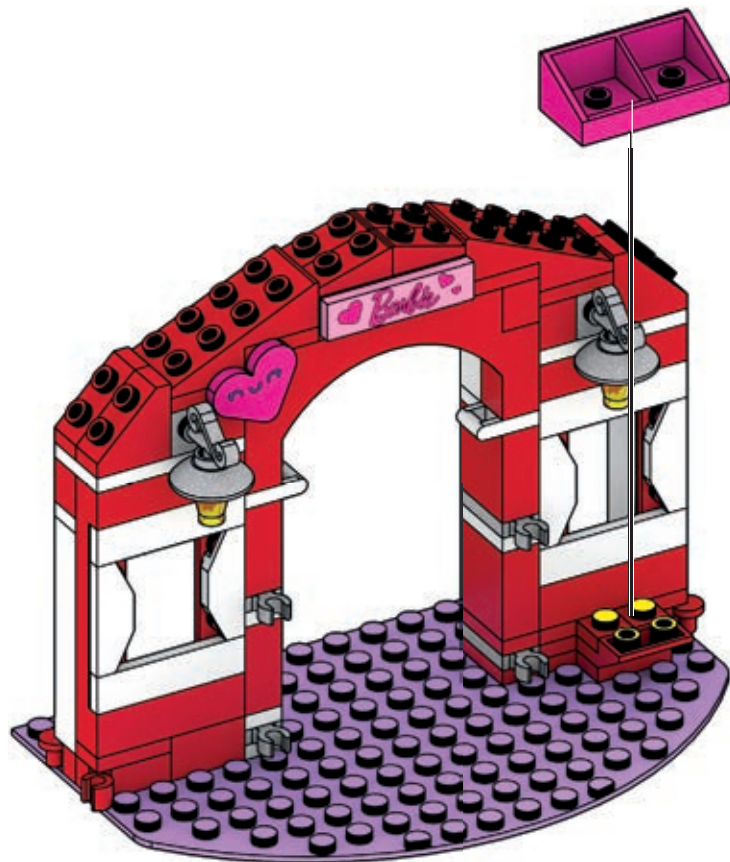

41

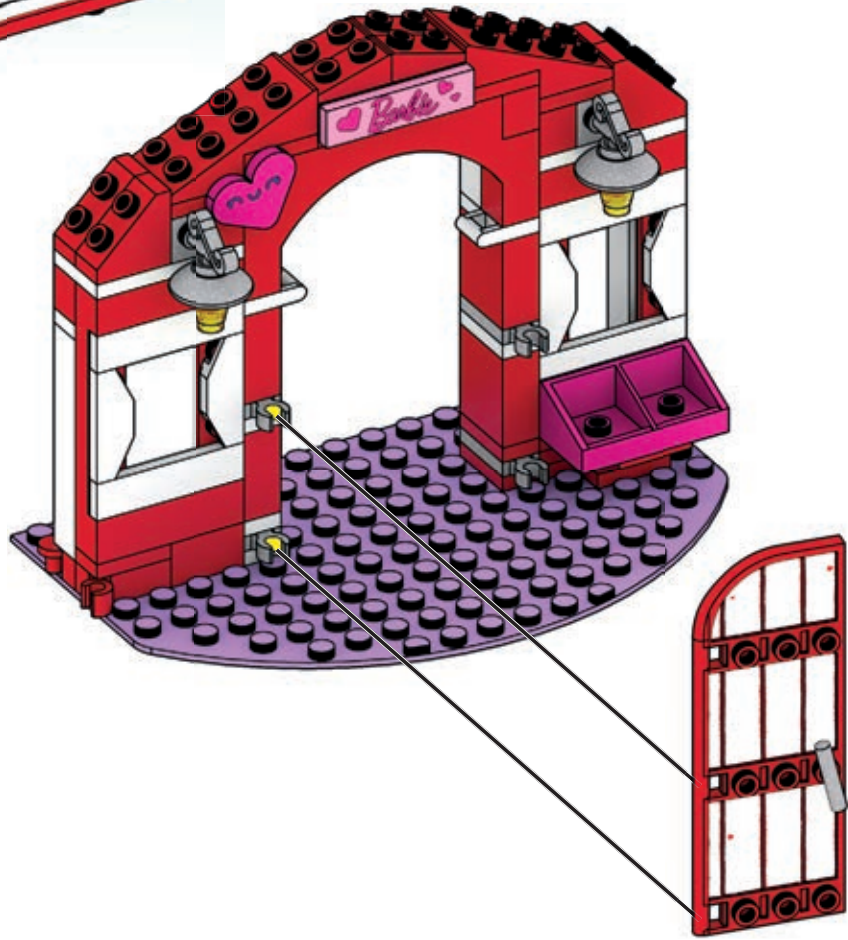
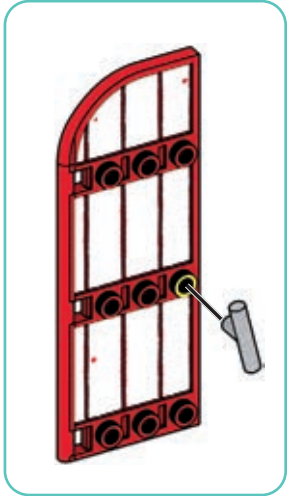
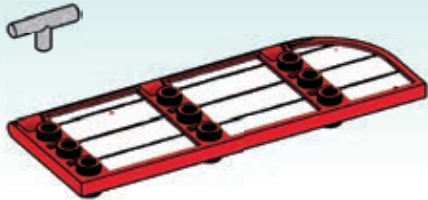

42

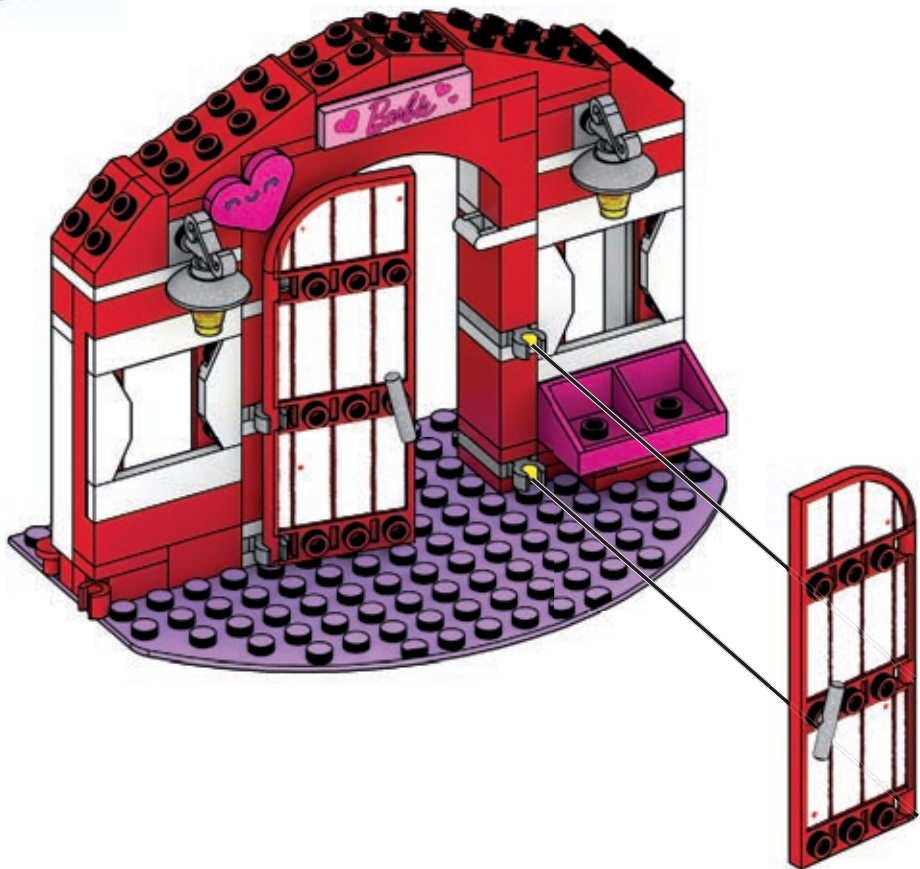
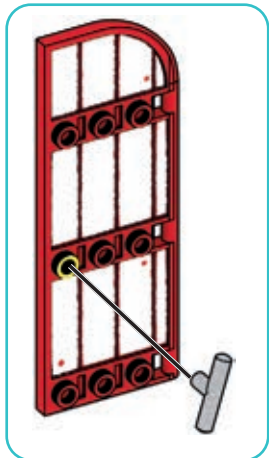
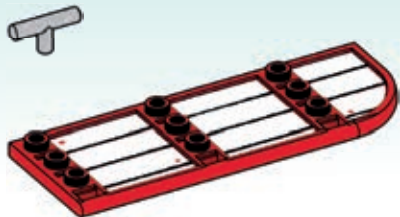

43

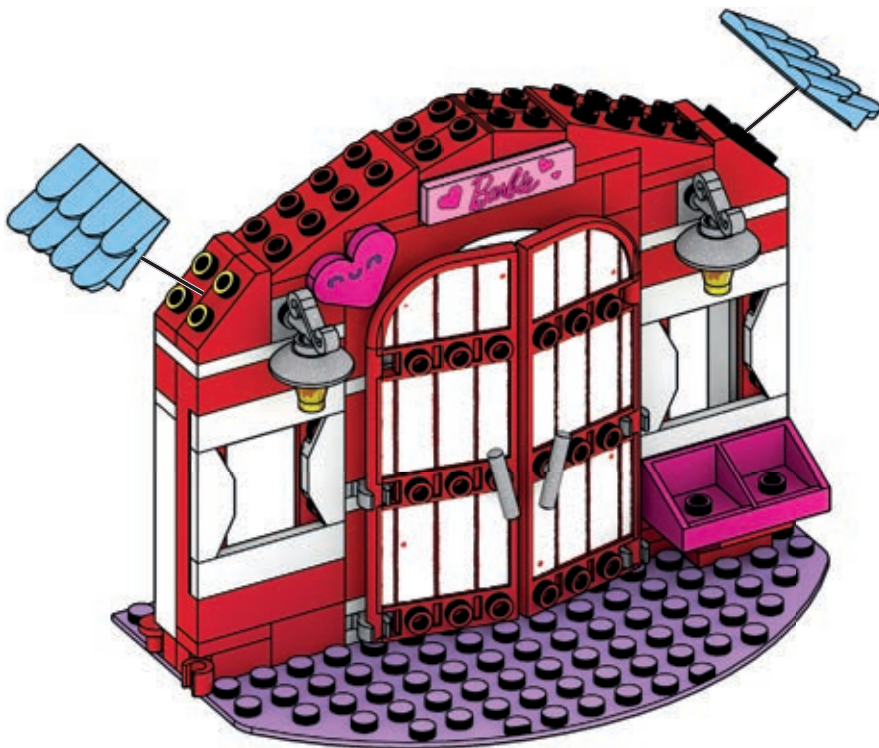

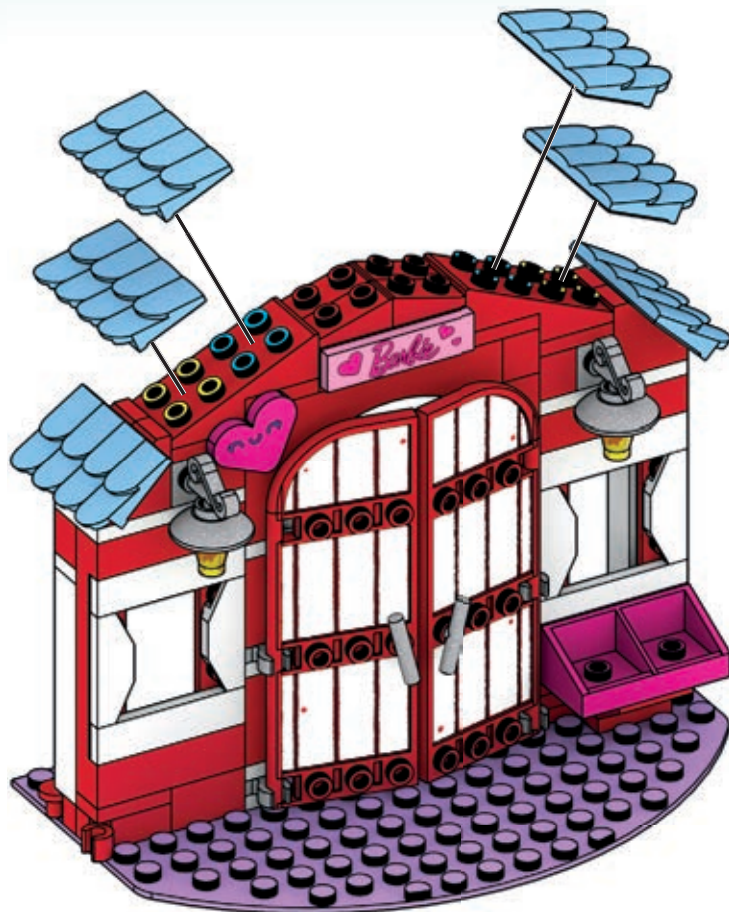



45

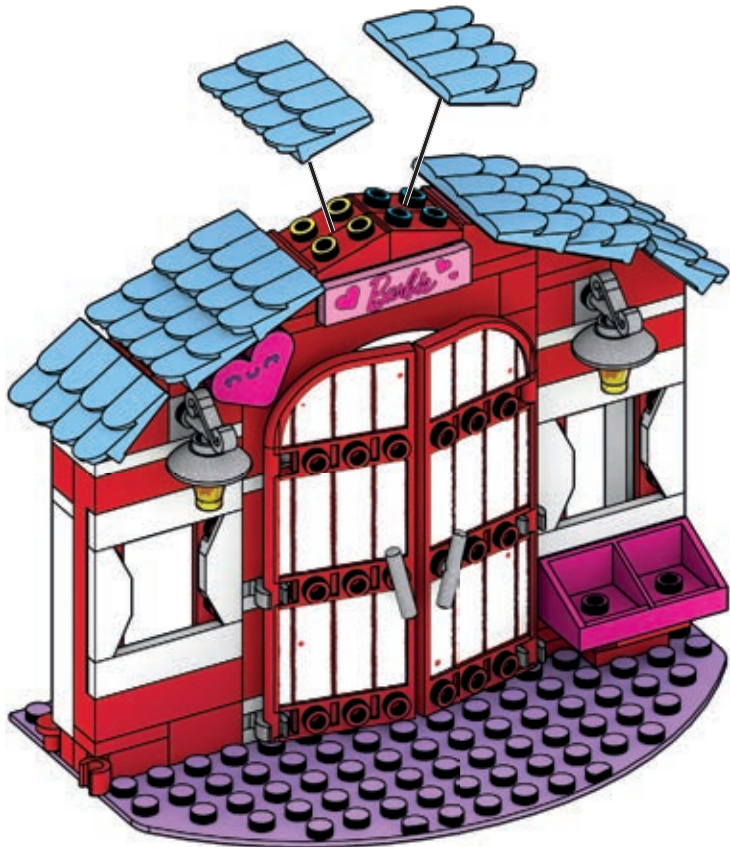

46

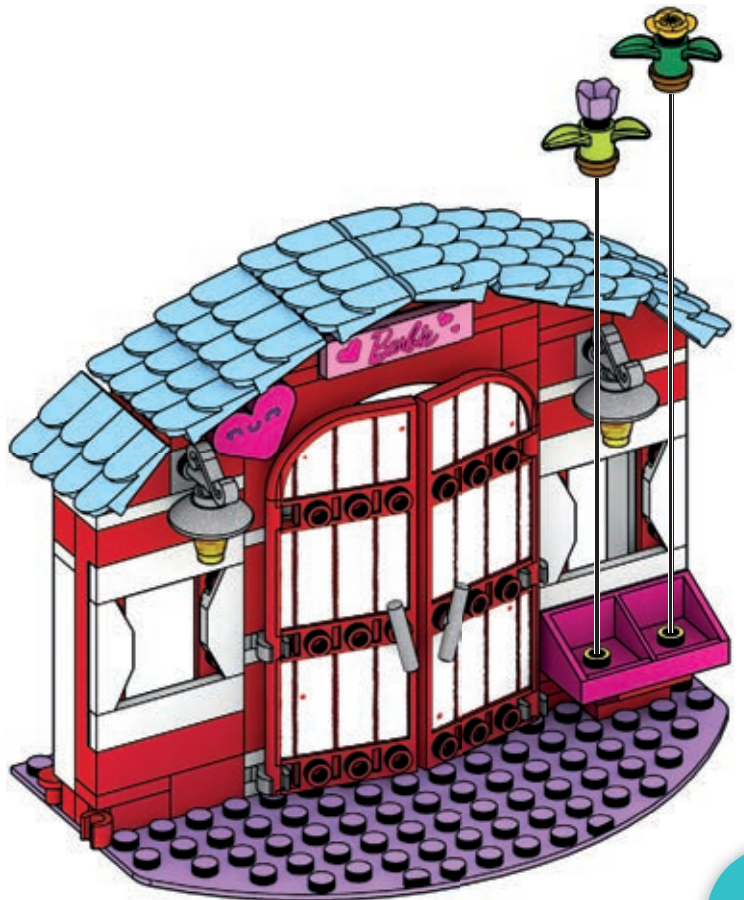

47

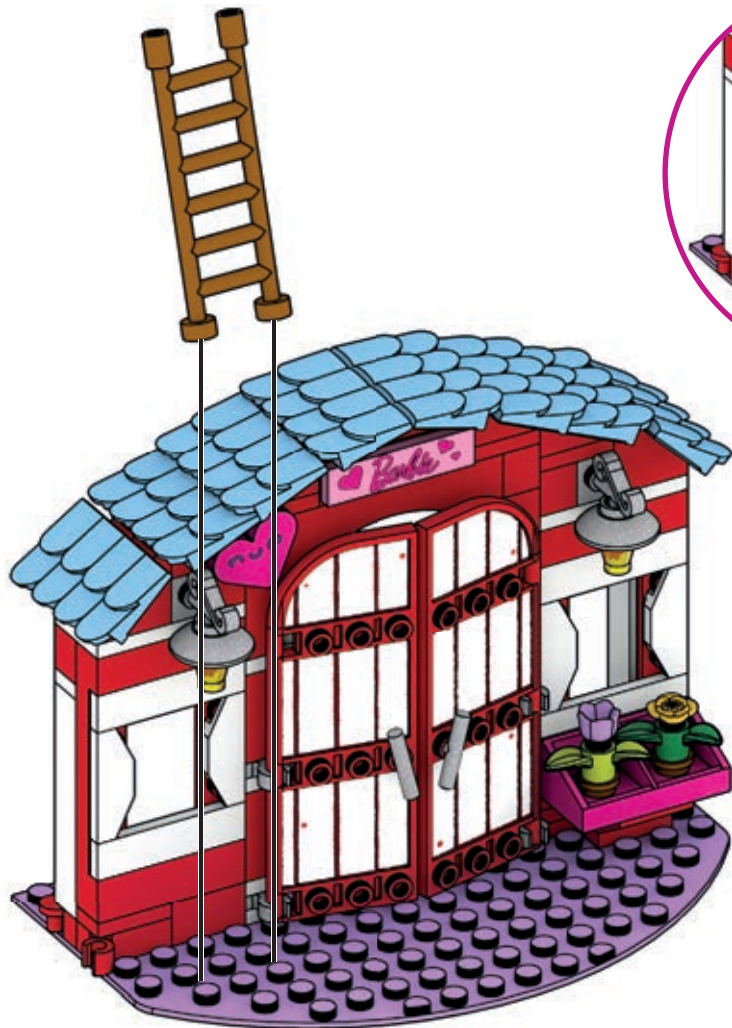
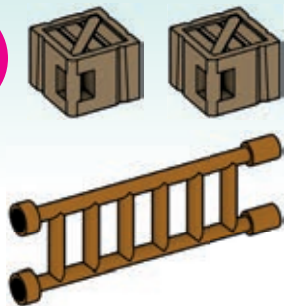

LET'S PLAY!  
AMUSONS-NOUS!

IAJUGARI! • A BRINCARI!  
LASS UNS SPIELEN! • НАИВНЕМ ИГРУ!





# LET'S BUILD THE STABLES! CONSTRUIVONS L'ÉCURIE!



¡CONSTRUYAMOS LOS ESTABLOS!  
CONSTRUAMOS OS ESTÁBULOS!  
DIE STÄLLE BAUEN!  
ПОСТРОИМ СТОЙЛА!

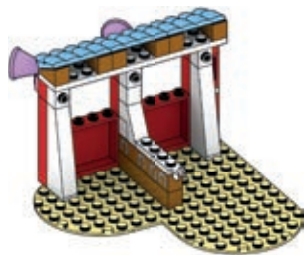

# CUSTOMIZE YOUR BARBIE FIGURE! PERSONNALISEZ VOTRE FIGURINE BARBIE!

¡PERSONALIZA TU BARBIE! • PERSONALIZE SUA BARBIE!  
DIE BARBIE-FIGUREN INDIVIDUELL GESTALTEN!  
СДЕЛАЙ СВОЮ ФИГУРКУ БАРБИ УНИКАЛЬНОЙ!



48

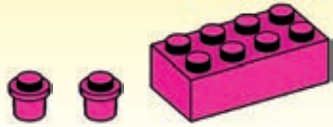

49



1

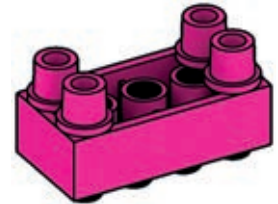

2



50

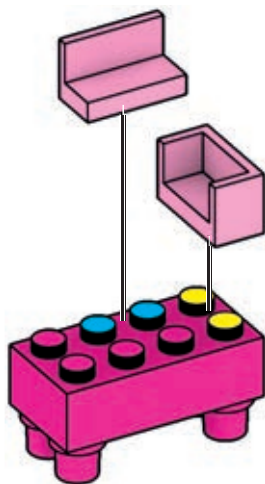
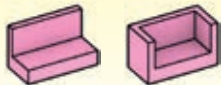

51

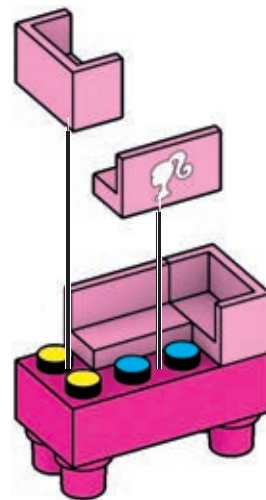
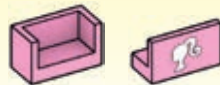

52

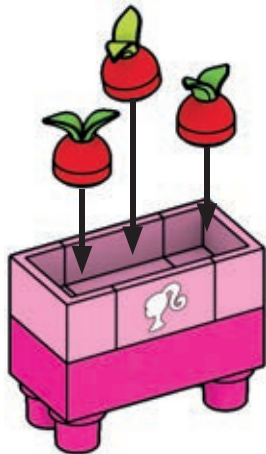
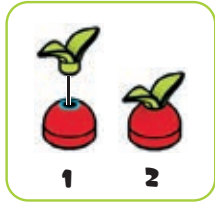
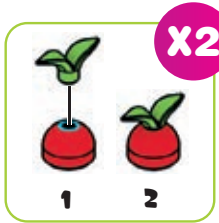

53

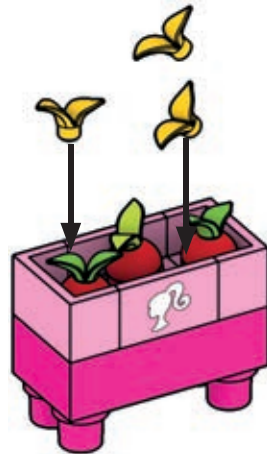



54

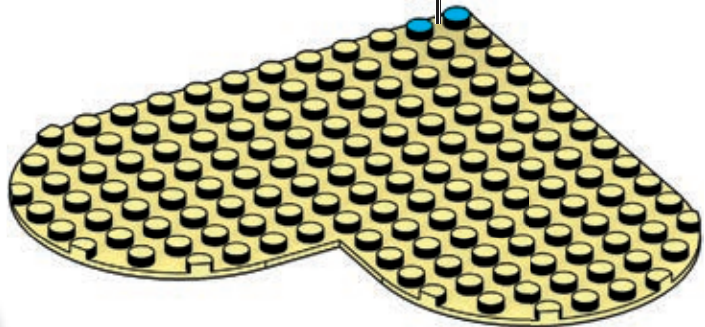
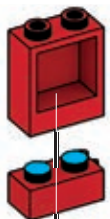
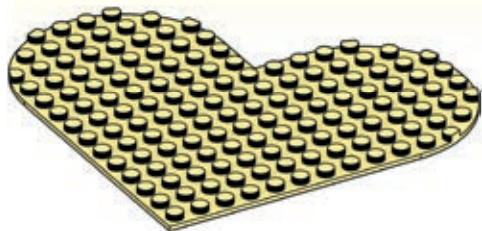
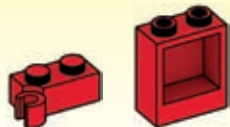

55

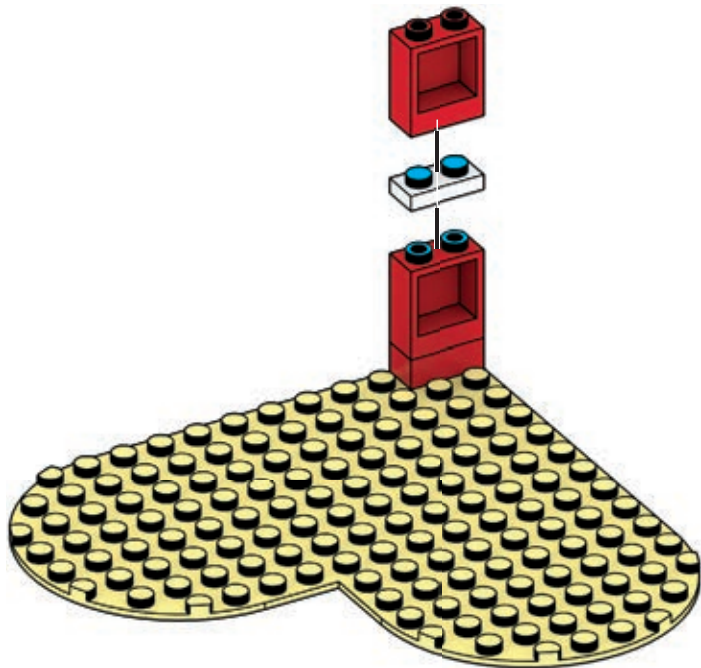

56

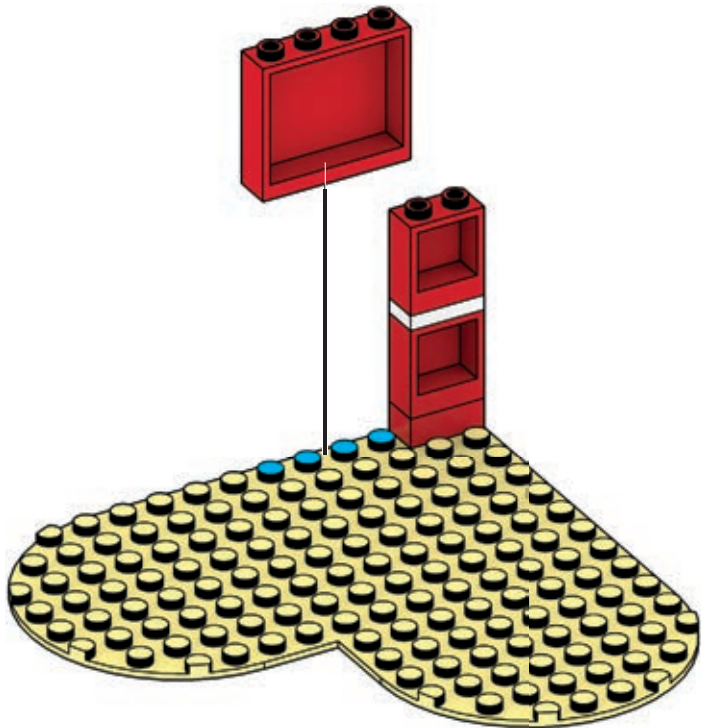

57

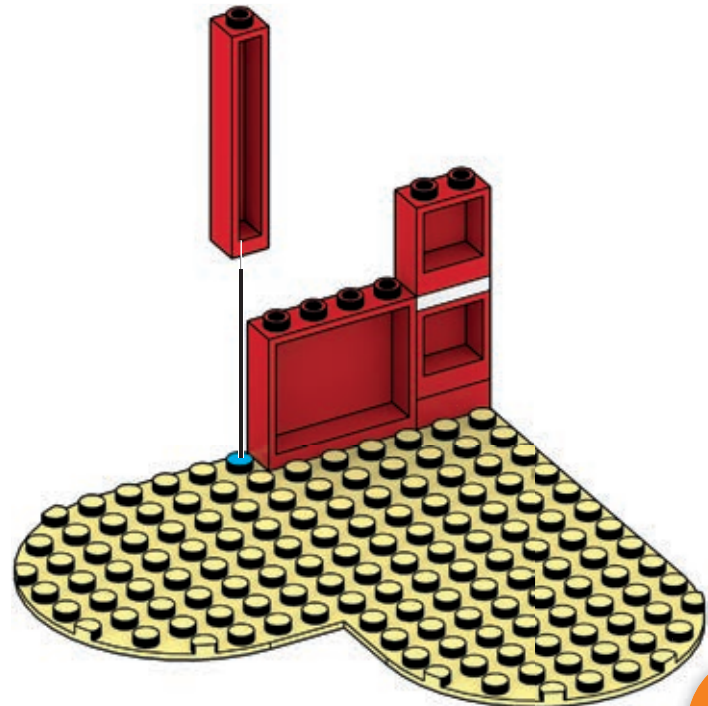

58

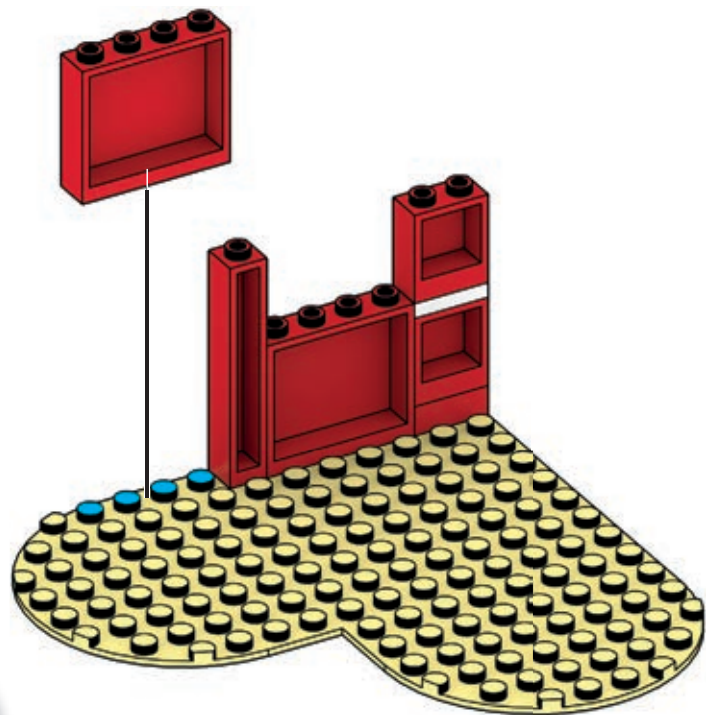

59

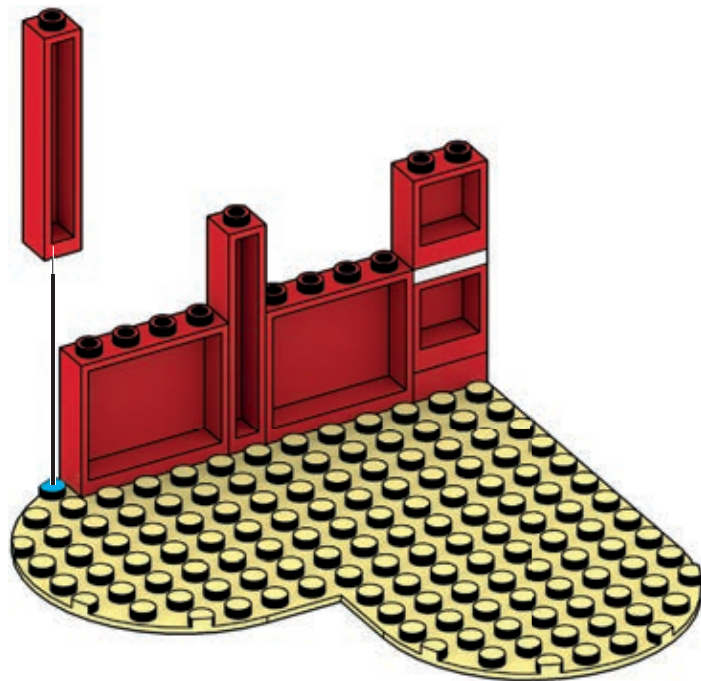



60

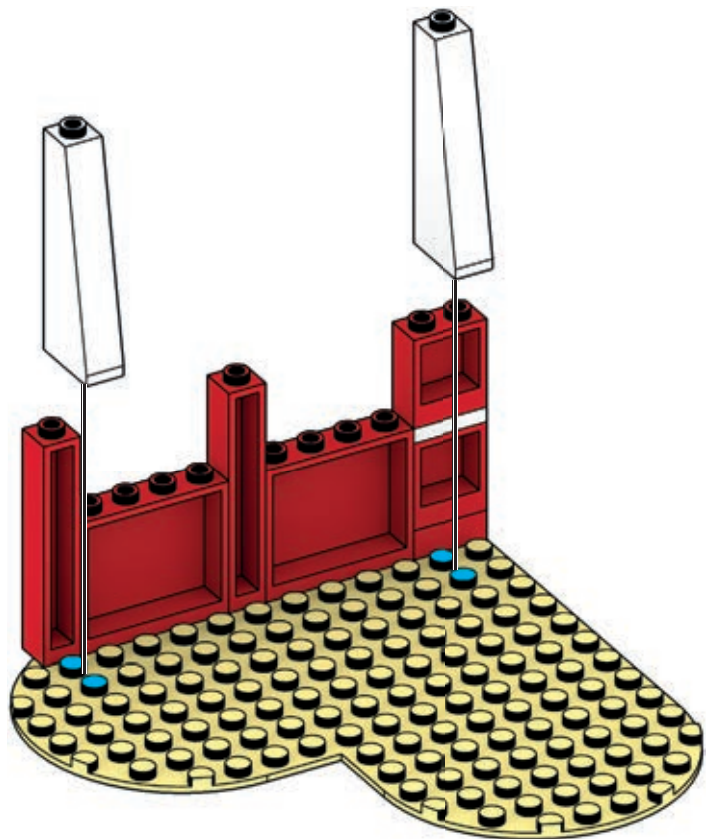
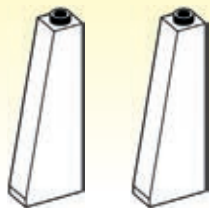

61

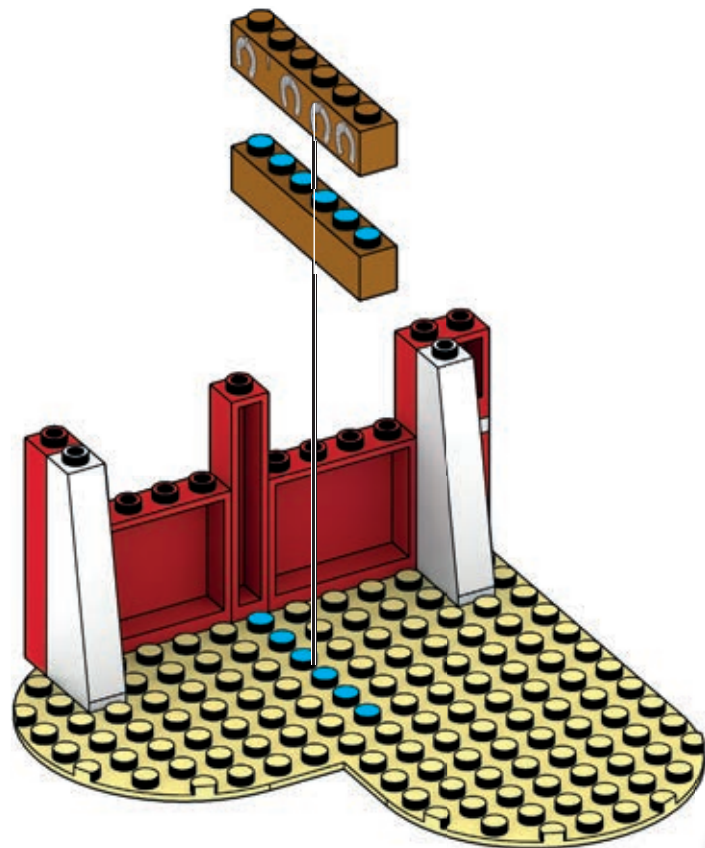
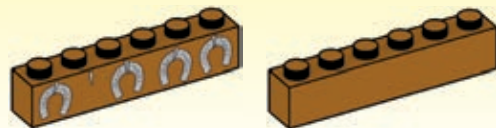

62

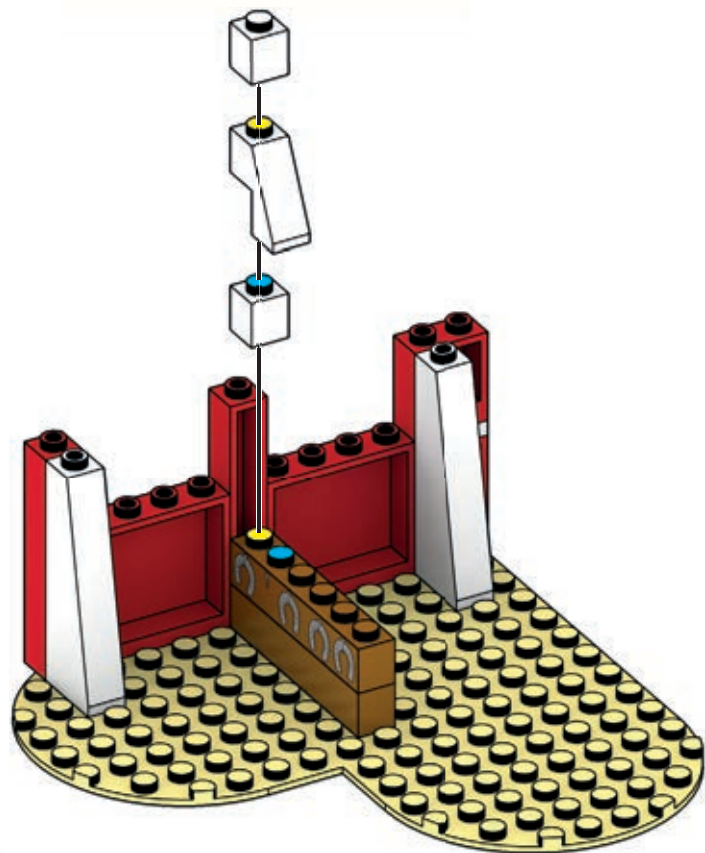
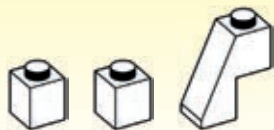

63

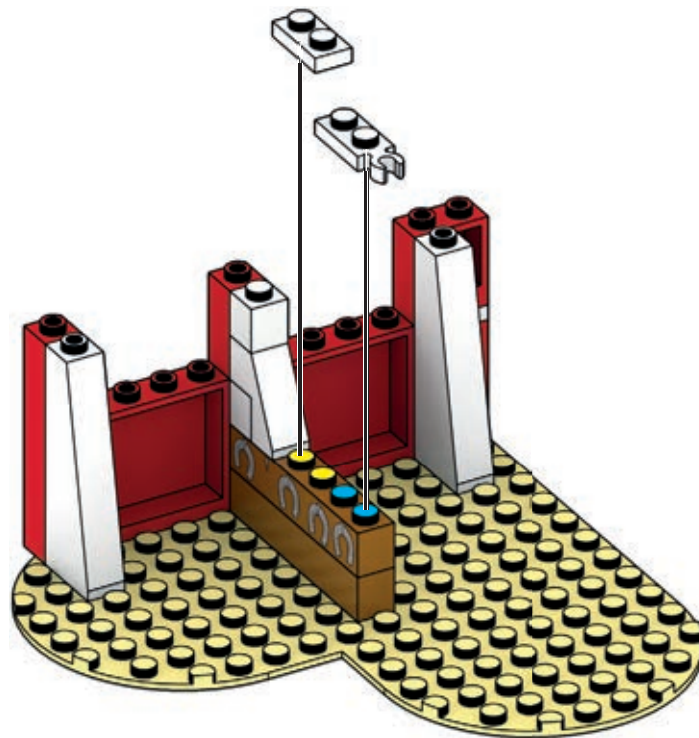

64

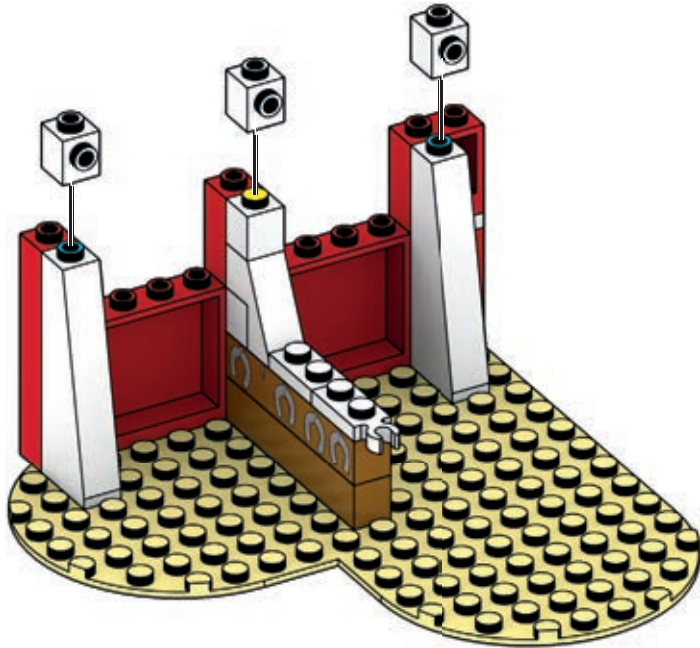

1

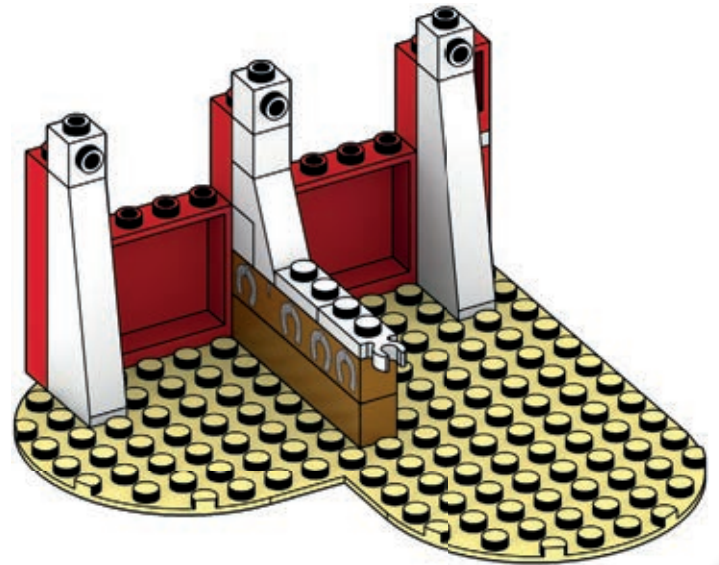

2

65



x2

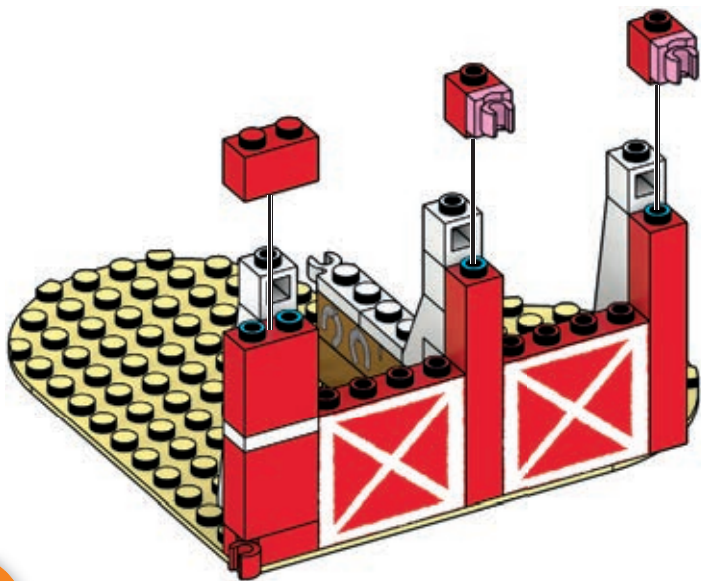

66

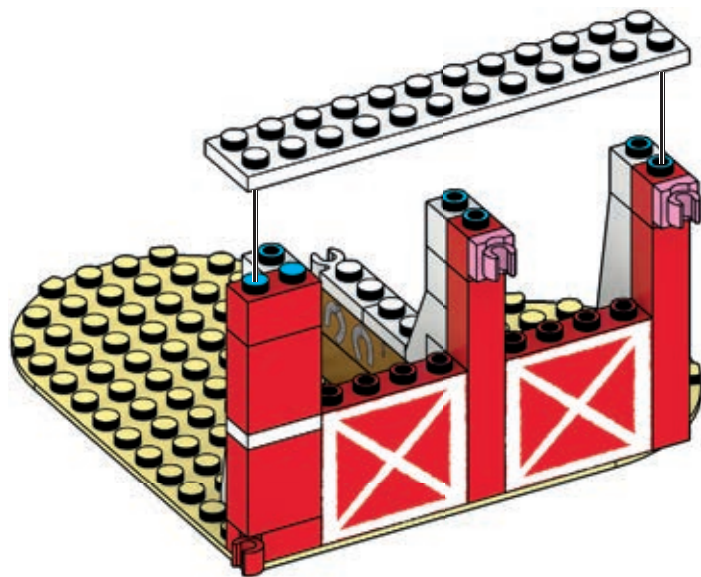
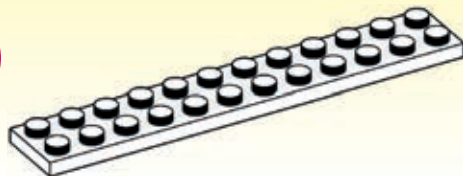



67

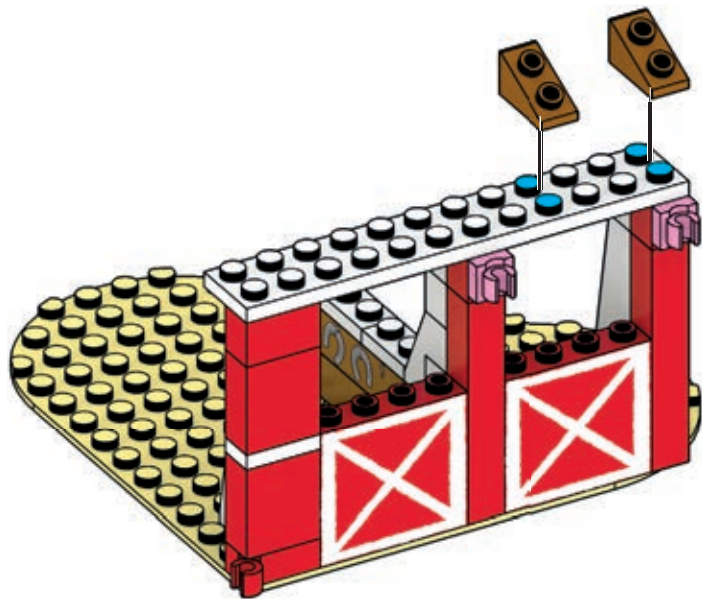

68

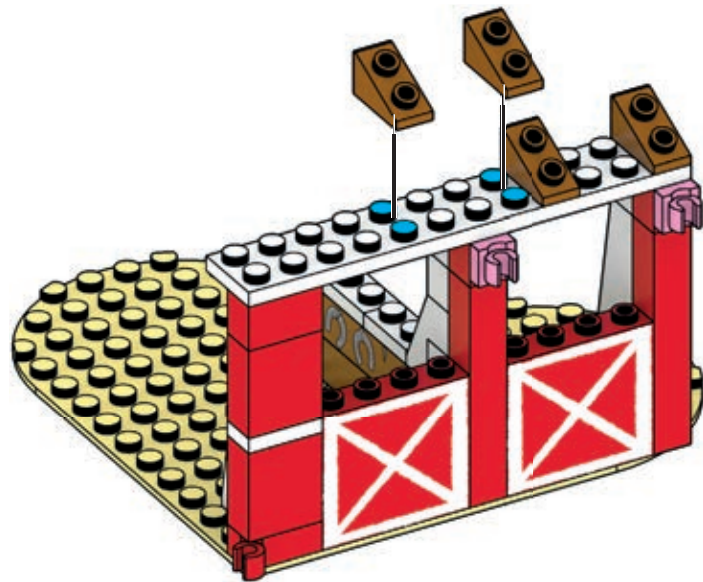



69

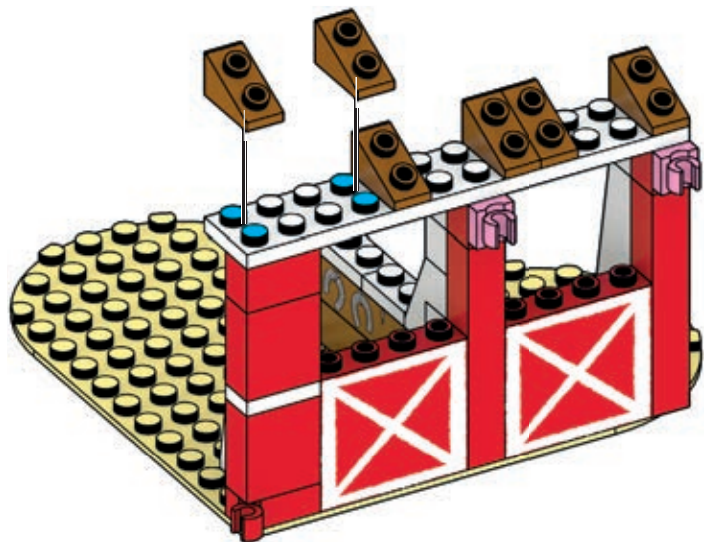

70

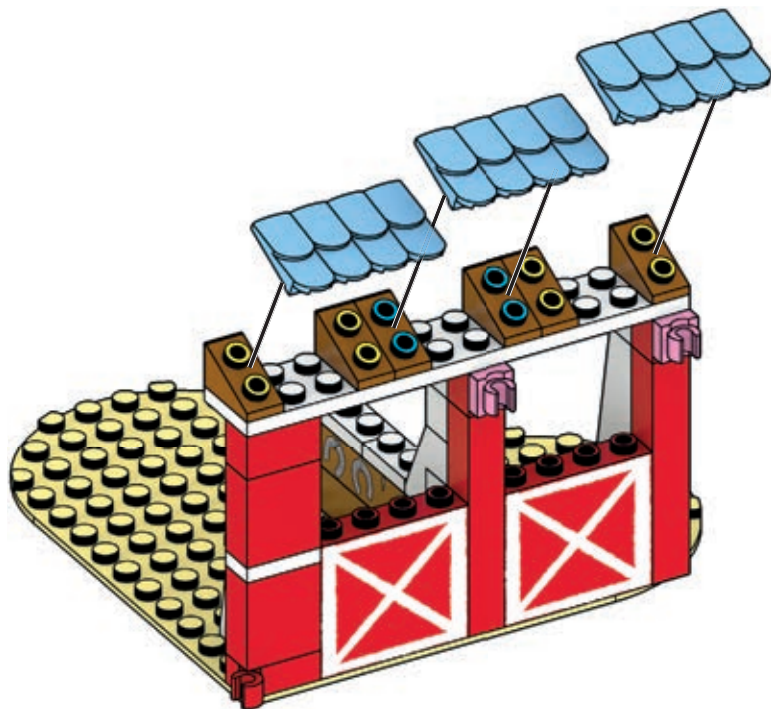

71

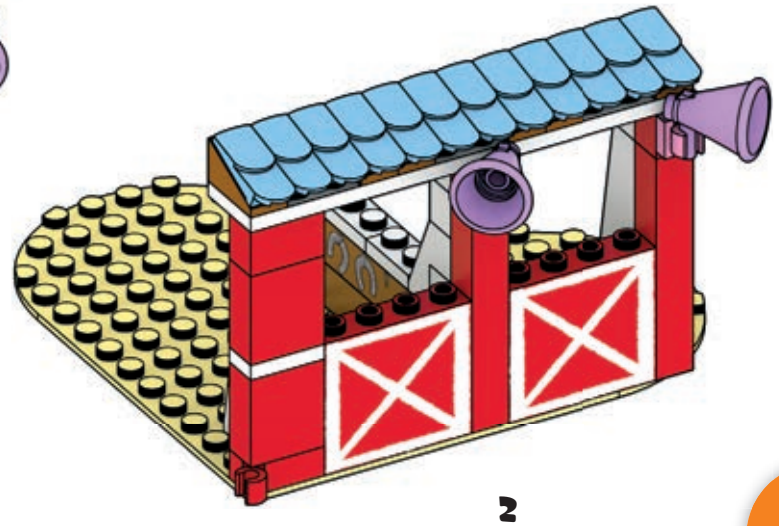
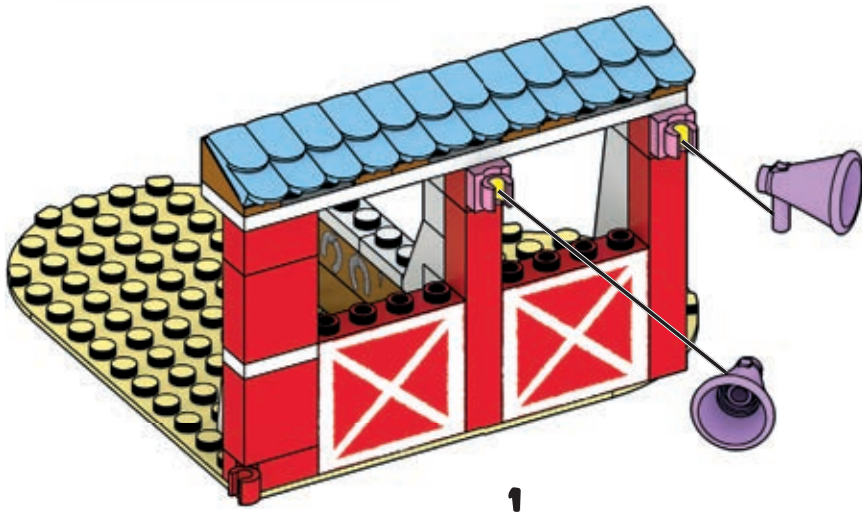

72

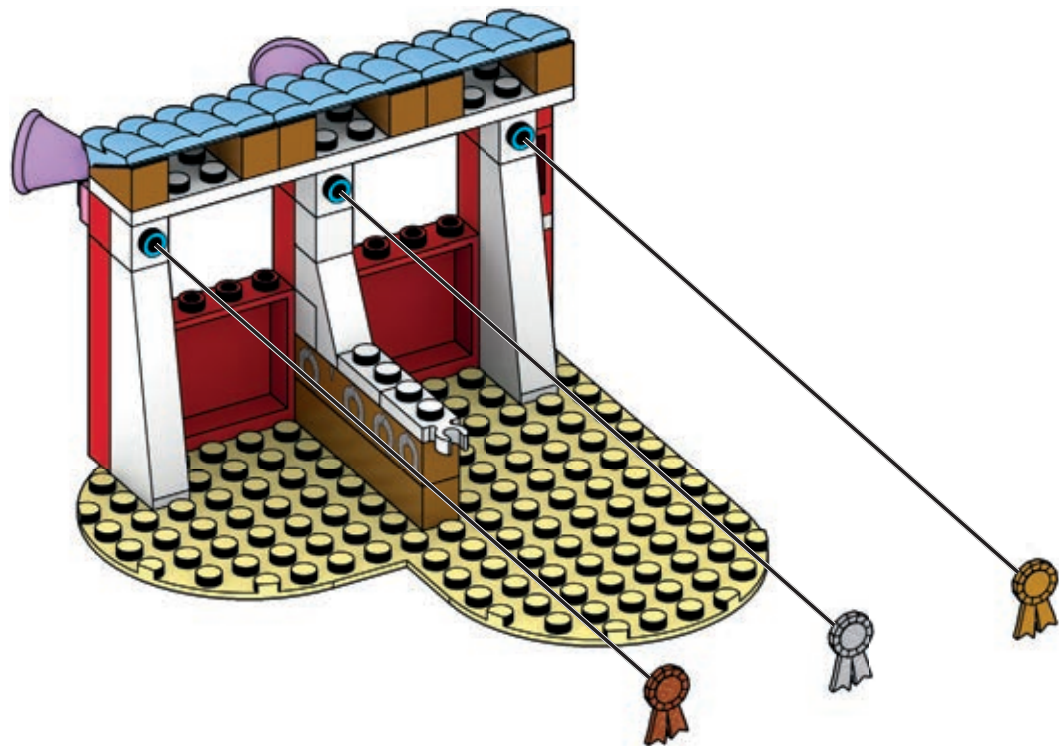

73

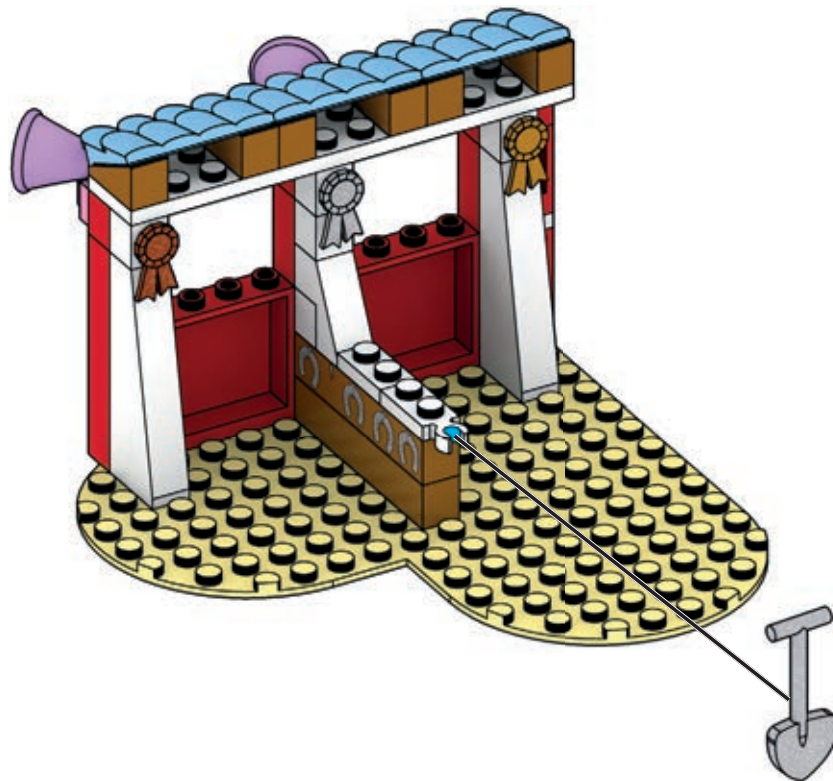



74

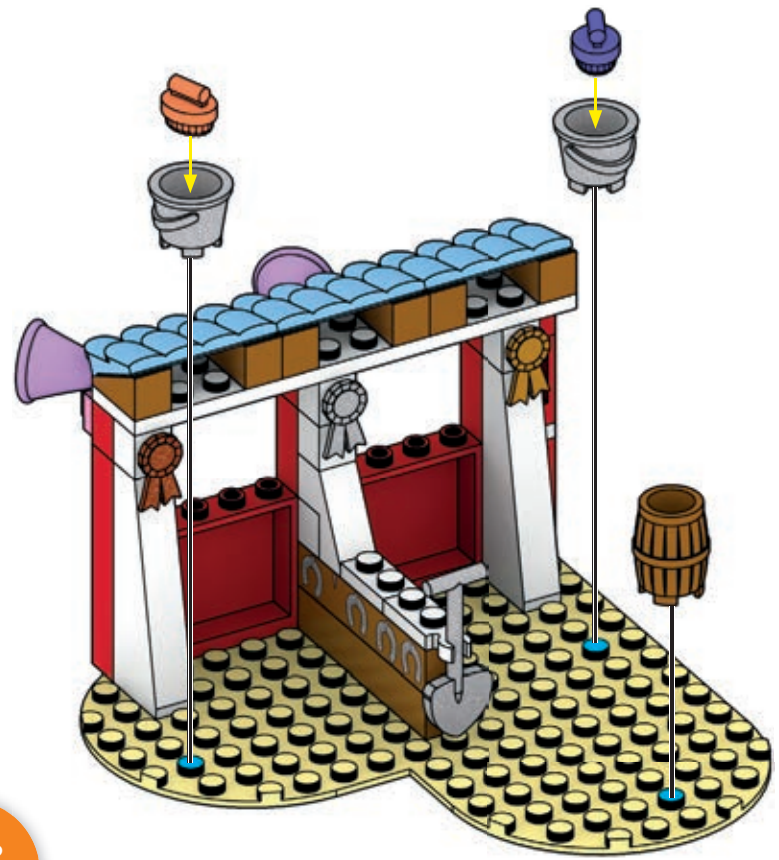

75





**LET'S PLAY!**  
**AMUSONS-NOUS!**  
IAJUGAR! • A BRINCAR!  
LASS UNS SPIELEN! • НАЧИНАЕМ ИГРУ!



# LET'S BUILD THE GARDEN! CONSTRUIVONS LE JARDIN!



¡CONSTRUYAMOS UN JARDÍN!  
CONSTRUAMOS UM JARDIM!  
EINEN GARTEN BAUEN!  
ДАВАЙ СОБЕРЕМ САД!



# CUSTOMIZE YOUR BARBIE FIGURE! PERSONNALISEZ VOTRE FIGURINE BARBIE!

¡PERSONALIZA TU BARBIE! • PERSONALIZE SUA BARBIE!  
DIE BARBIE-FIGUREN INDIVIDUELL GESTALTEN!  
СДЕЛАЙ СВОЮ ФИГУРКУ БАРБИ УНИКАЛЬНОЙ!



1



2



1



2



1



2

76



1



2

77



1



2

78



1



2

79



1



2



80

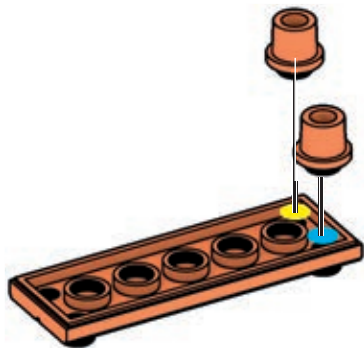

81

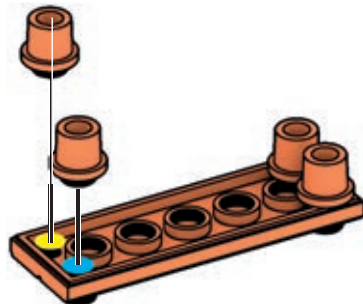

1

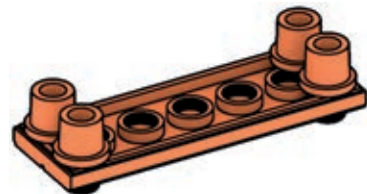

2

82

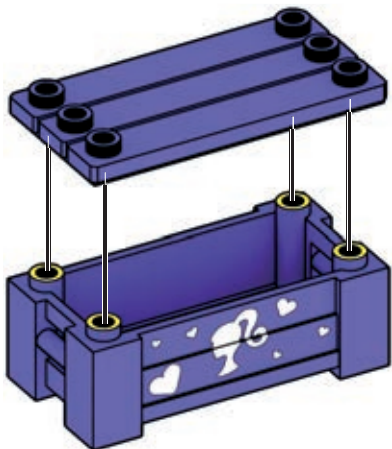
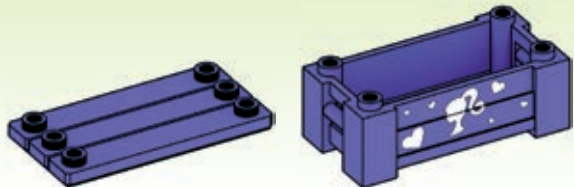

1



2



83

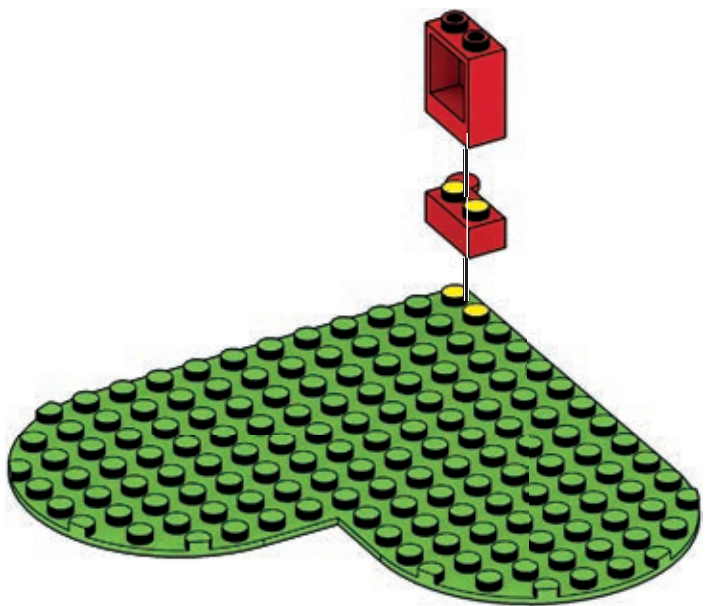
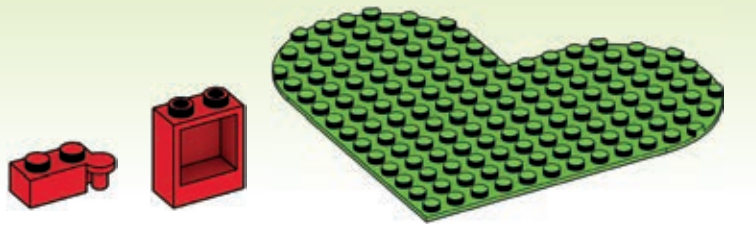

84

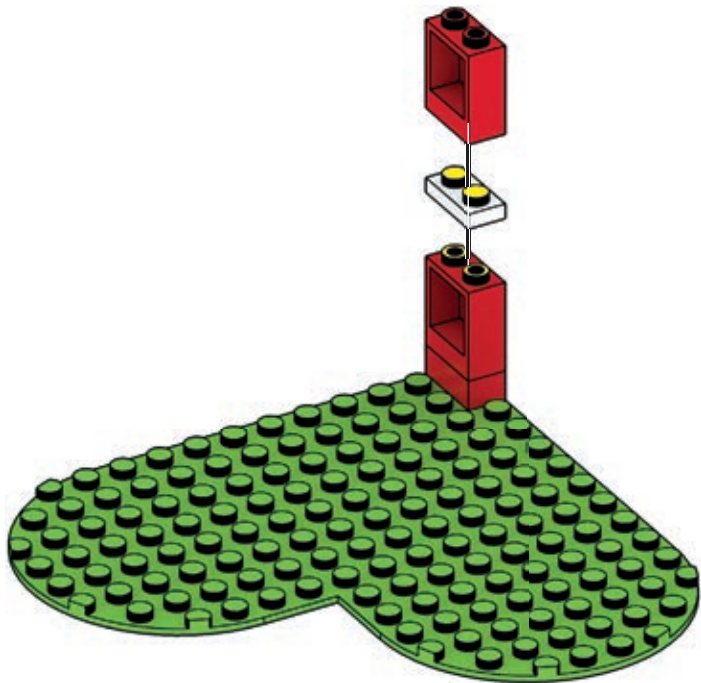

85

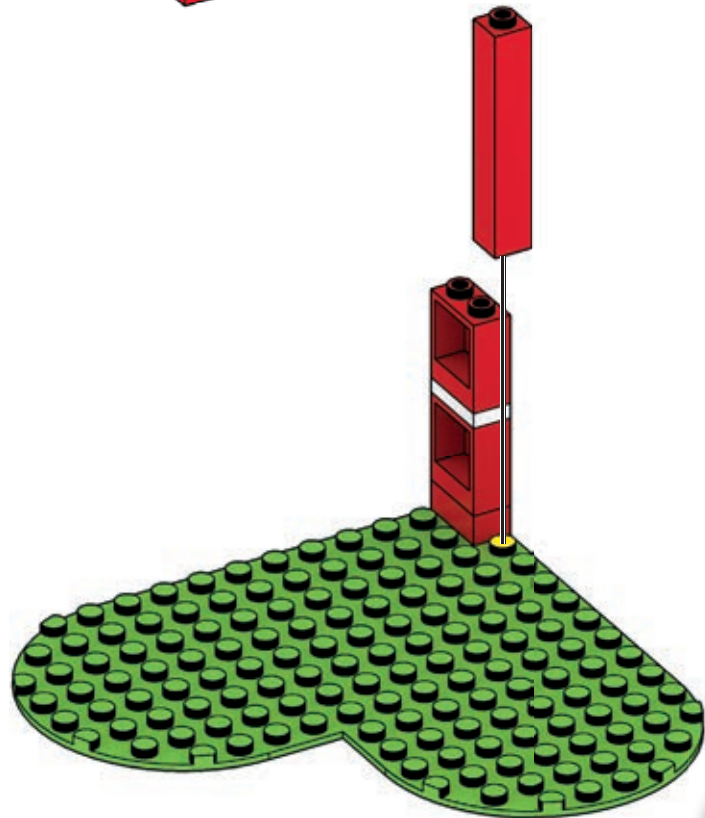

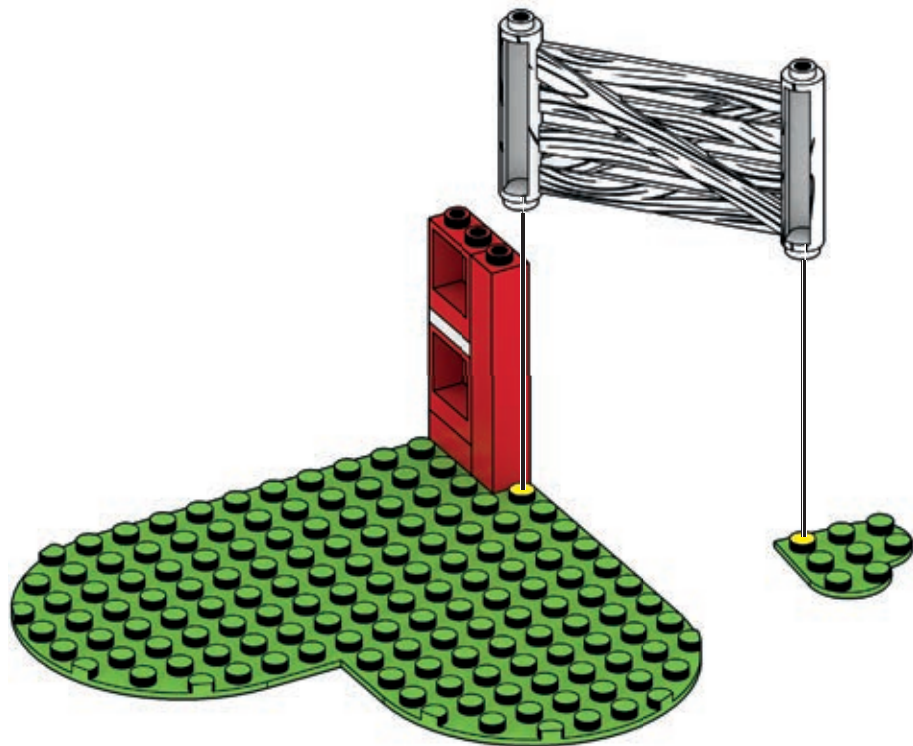
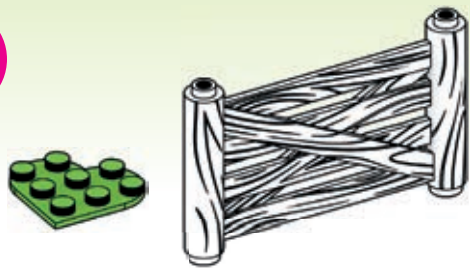



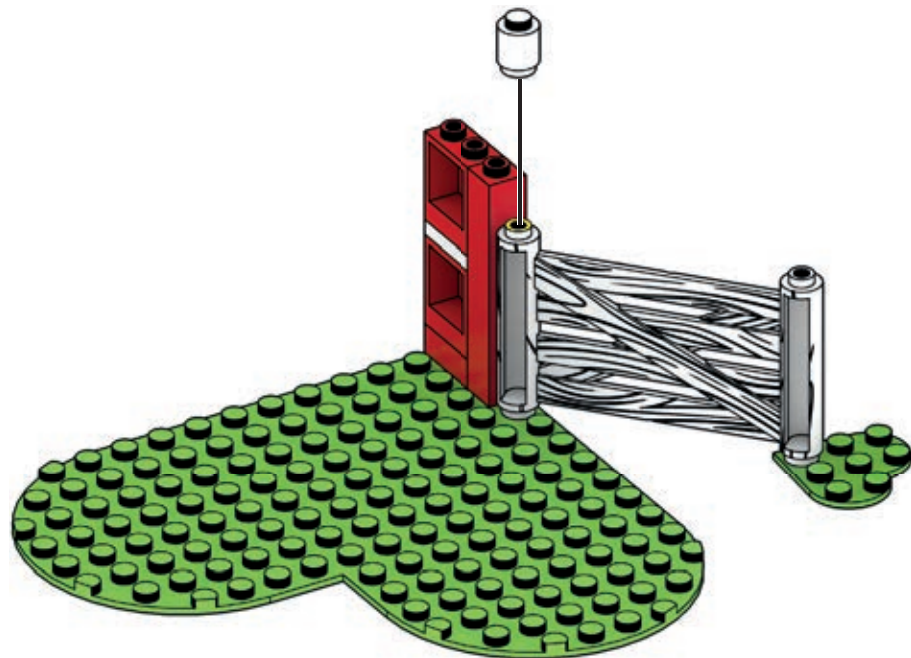

88

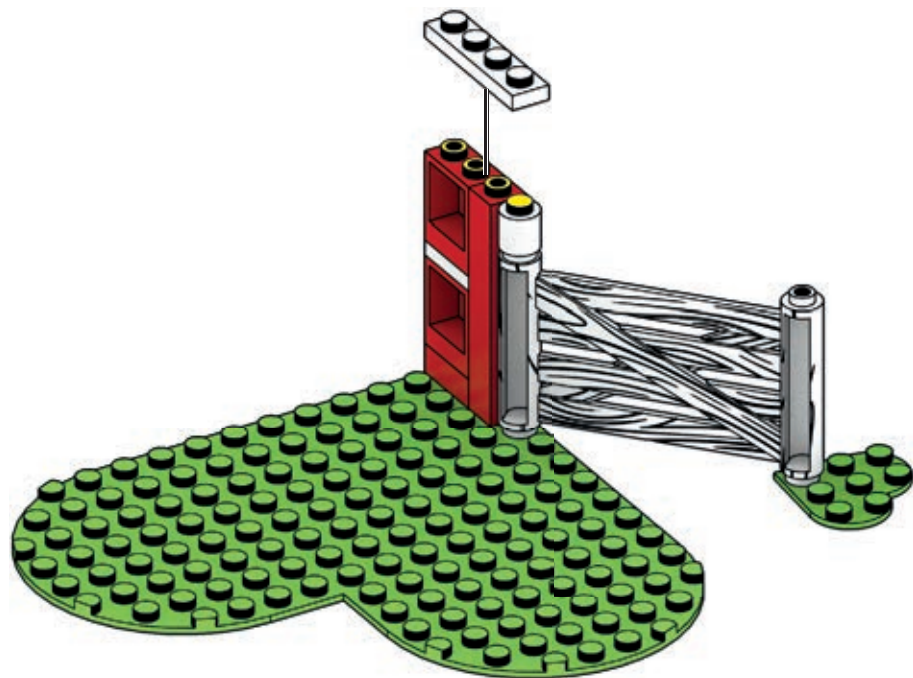

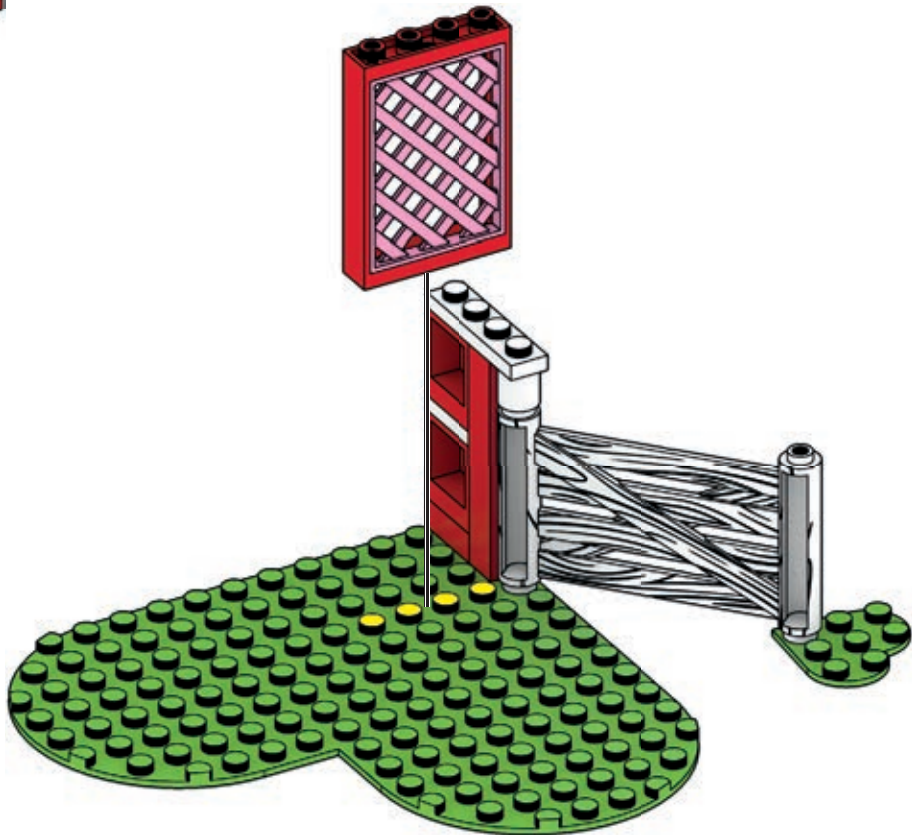

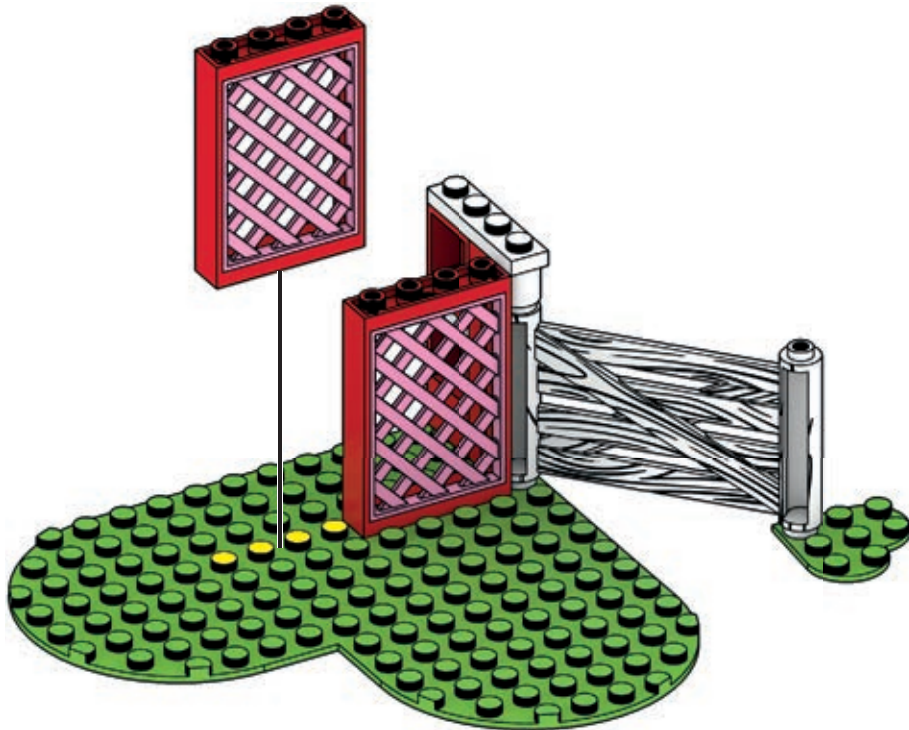



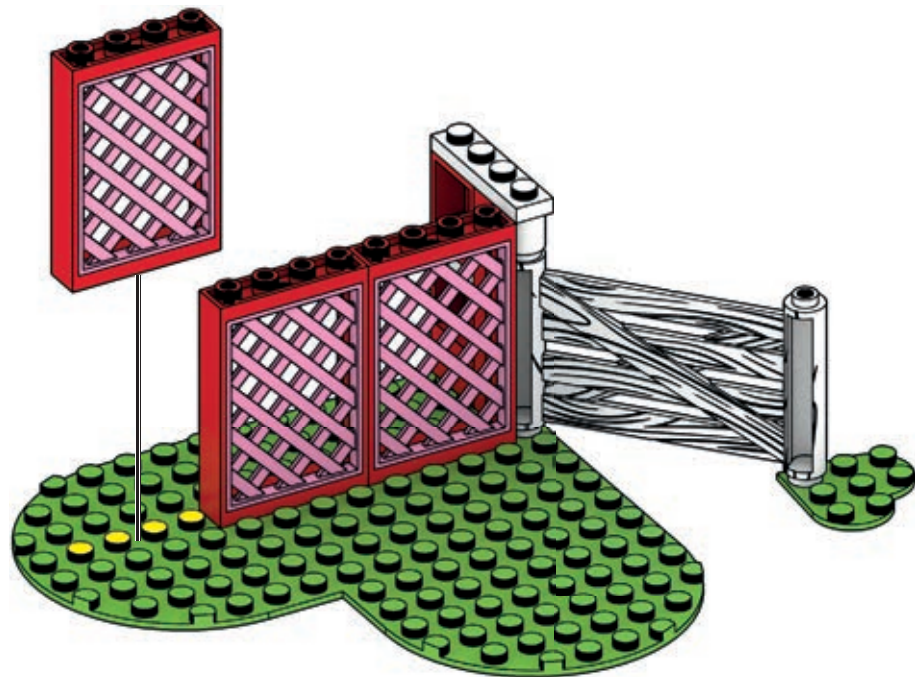

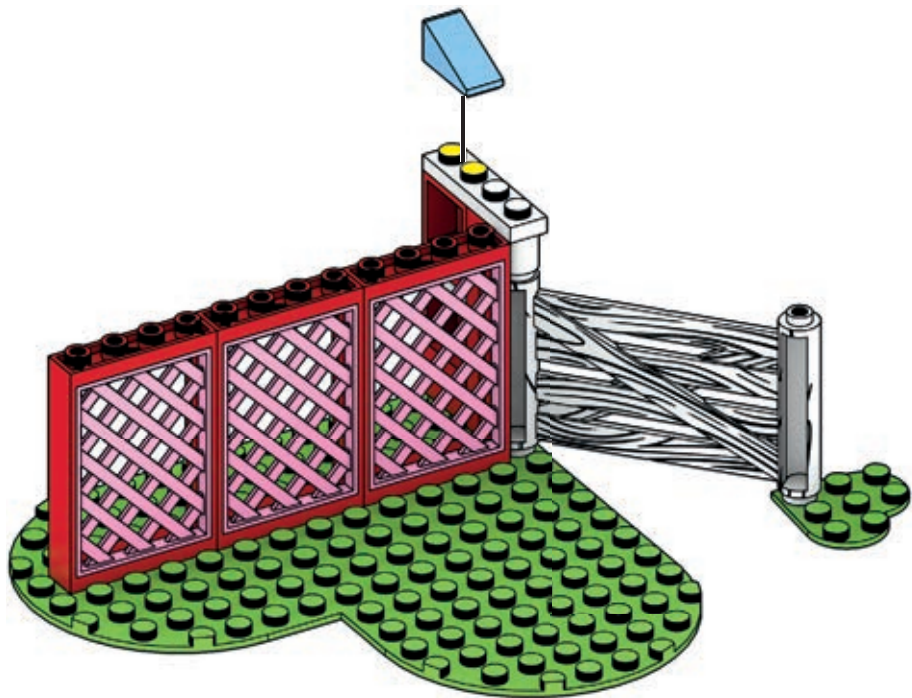

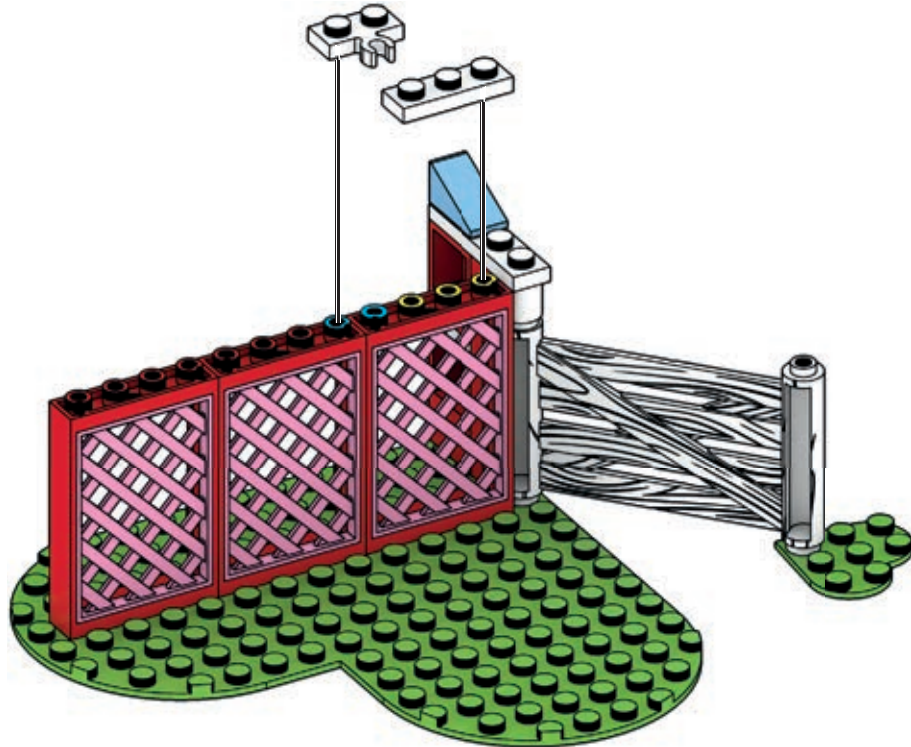

94

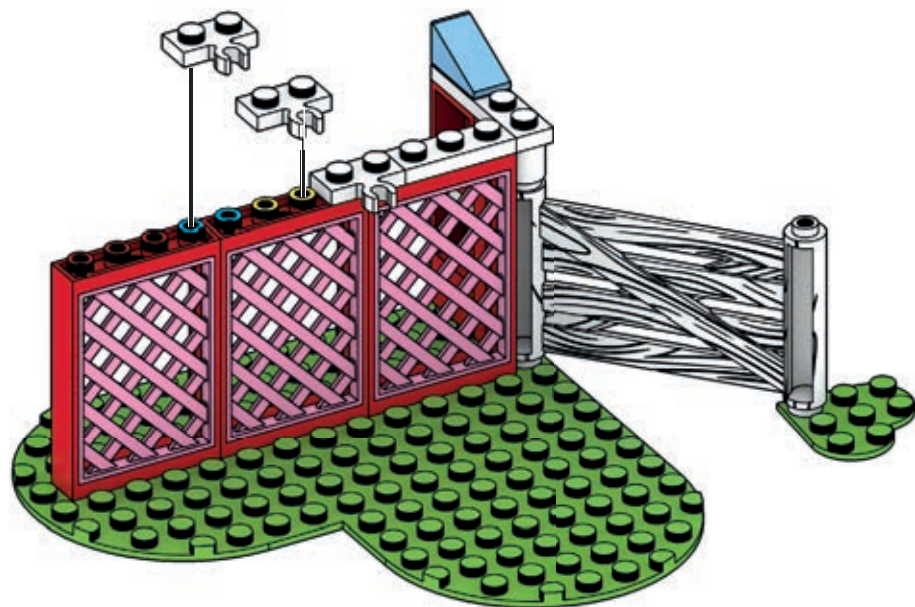

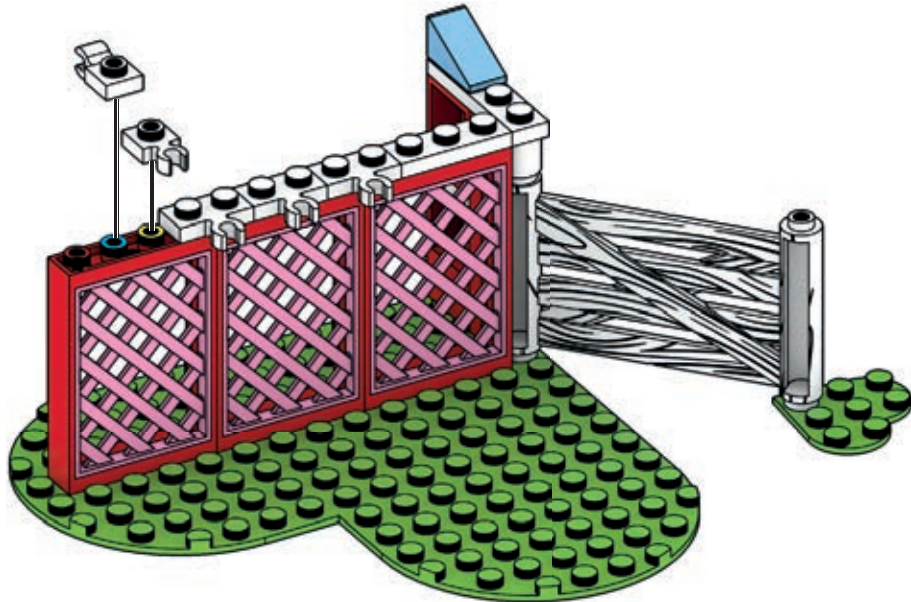



96

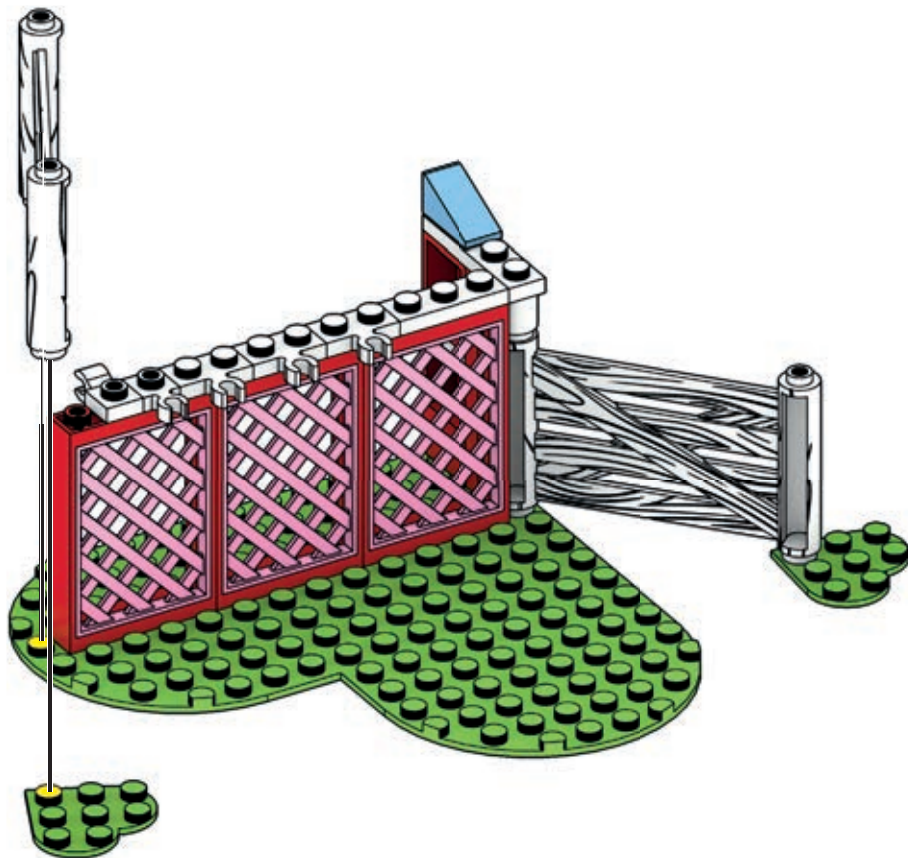
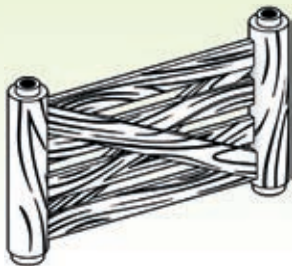

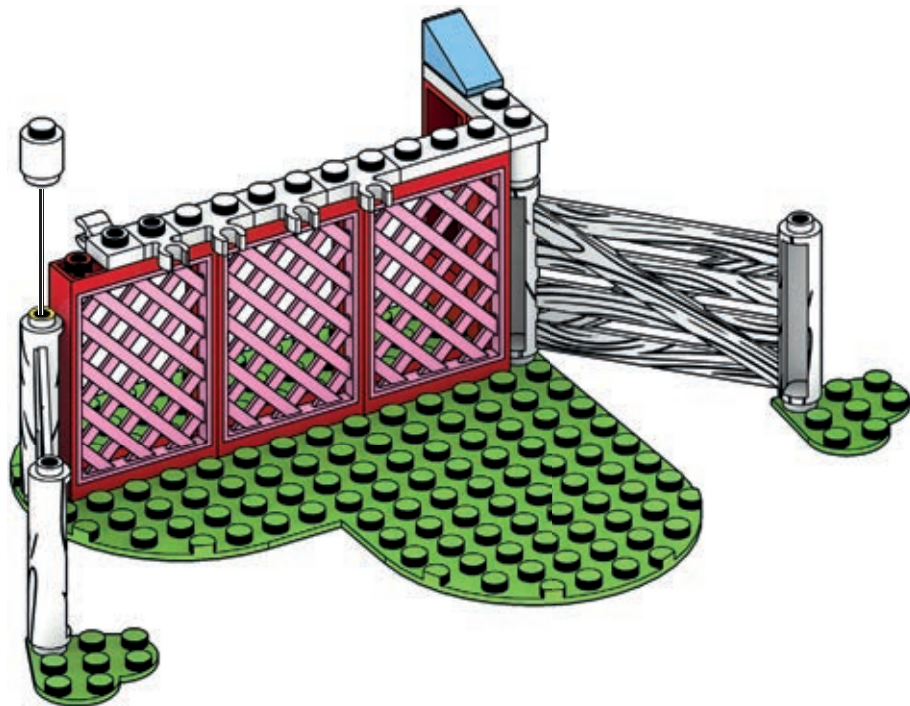

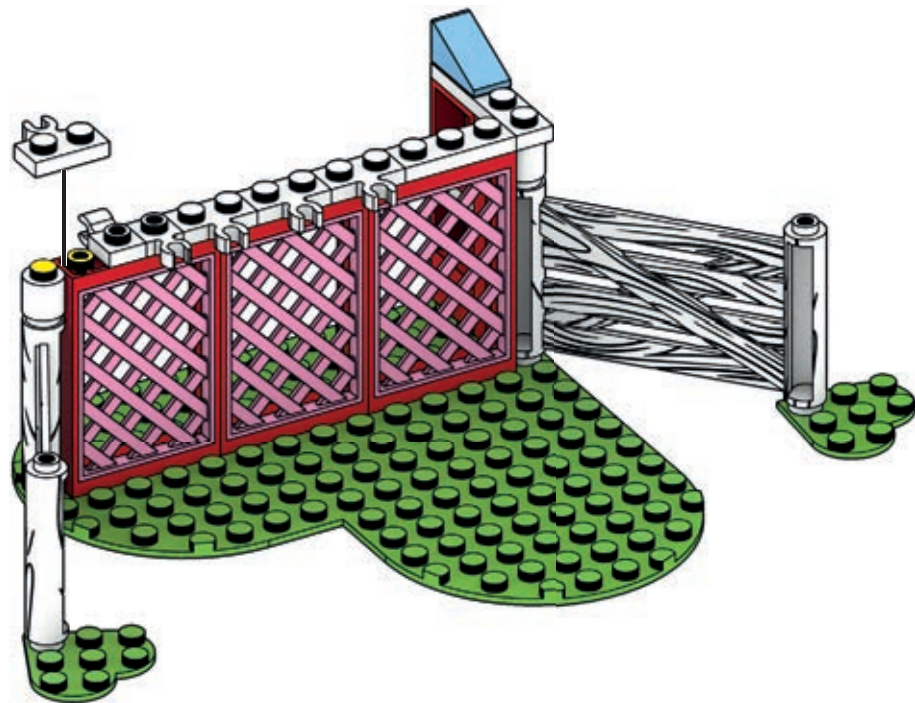

99

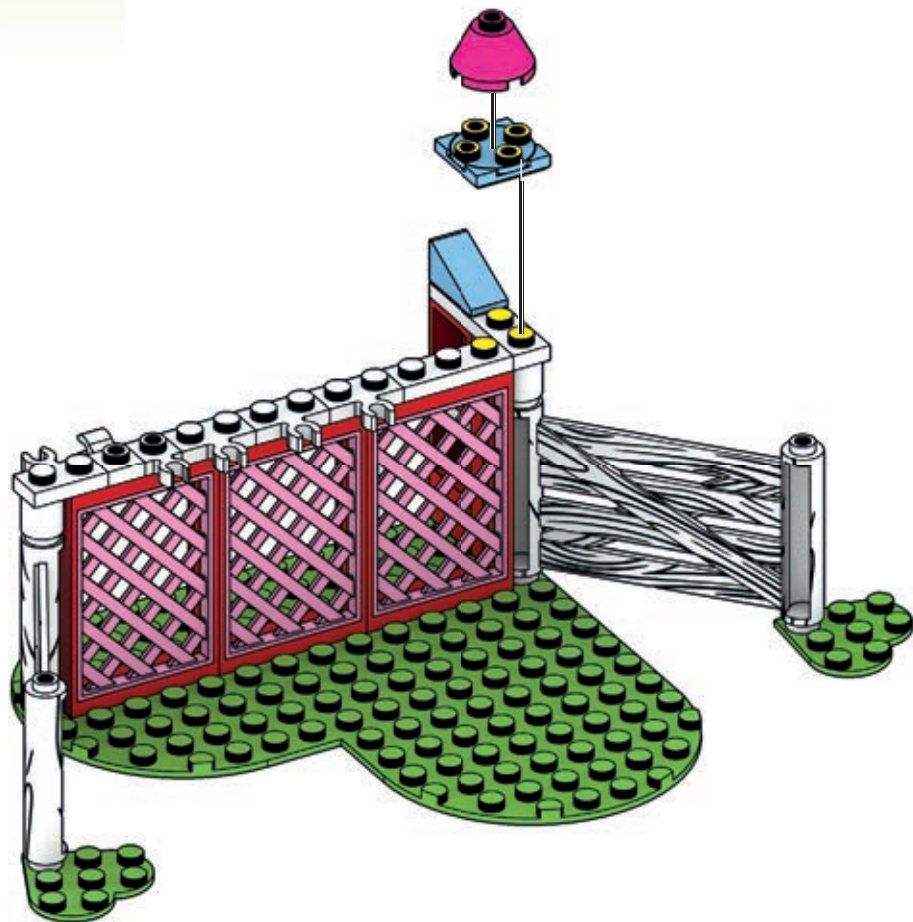

100

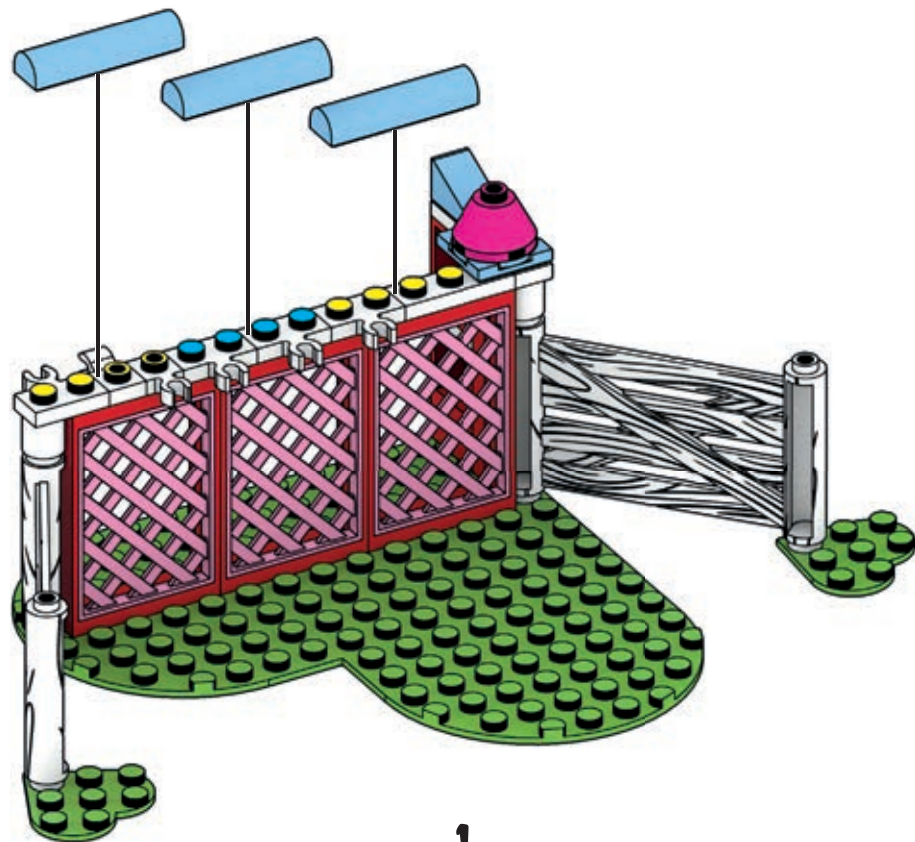

1



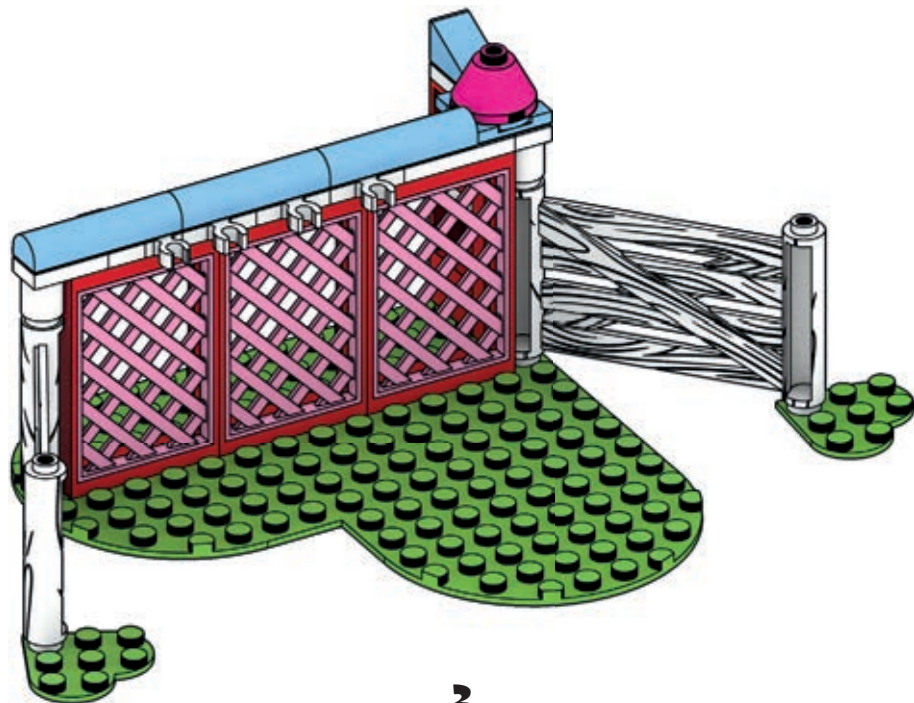

2

101

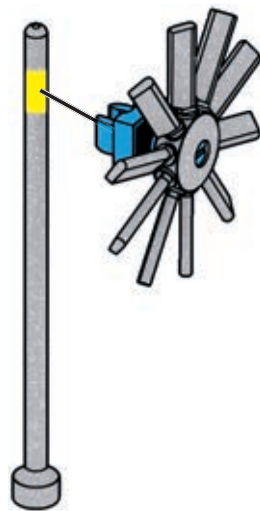
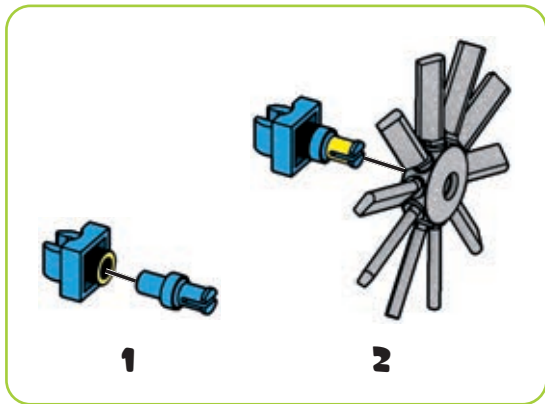

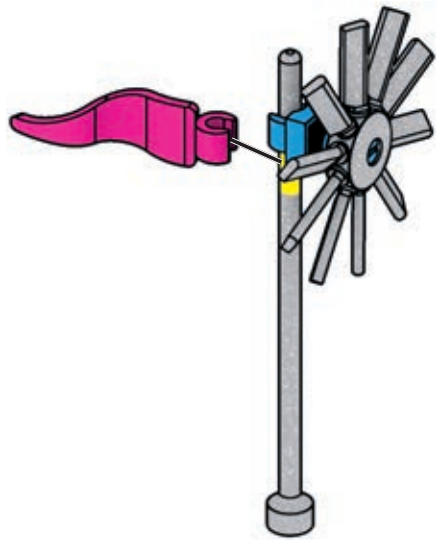

1

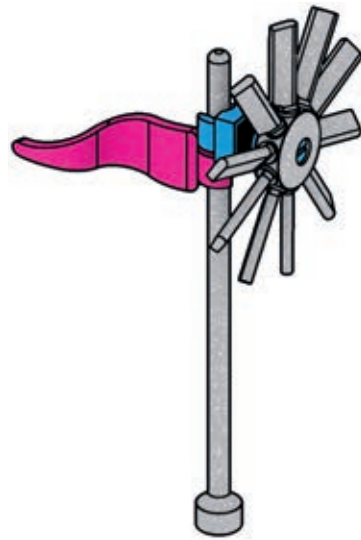

2

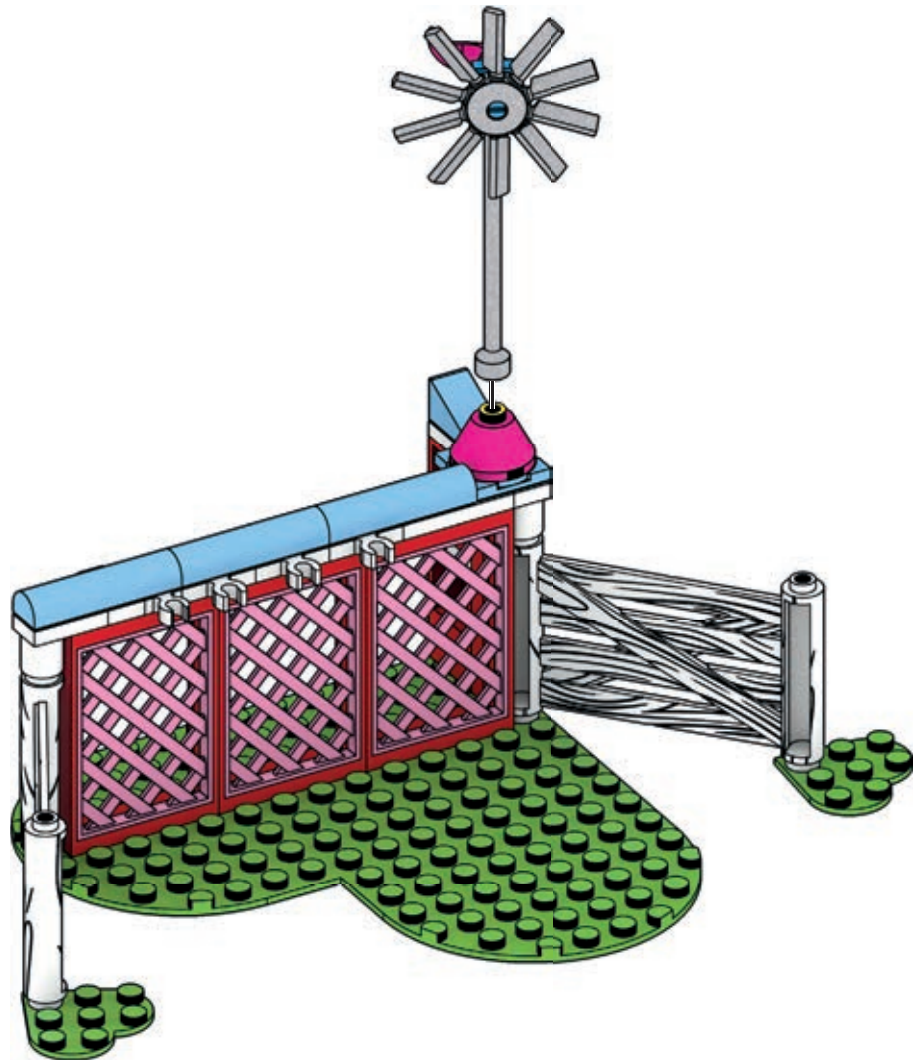

104

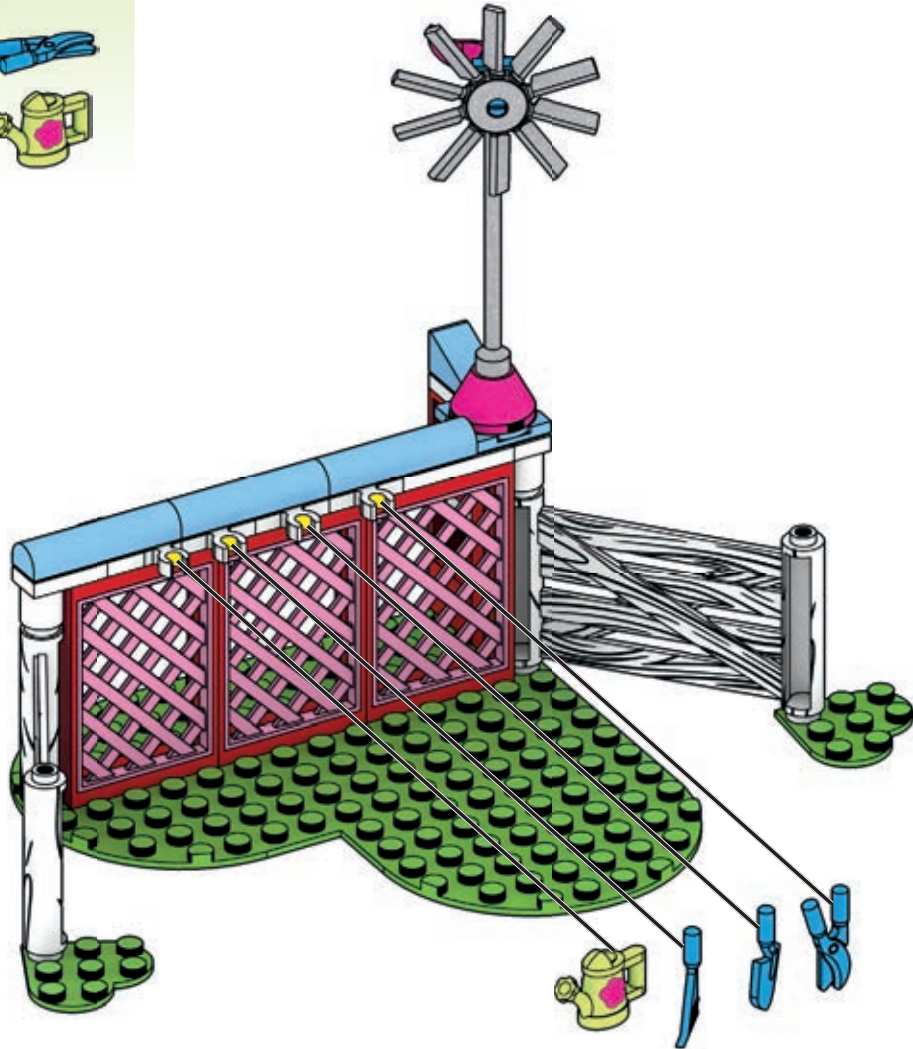
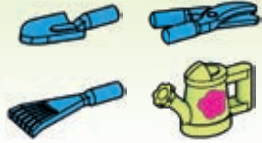









1



2

108

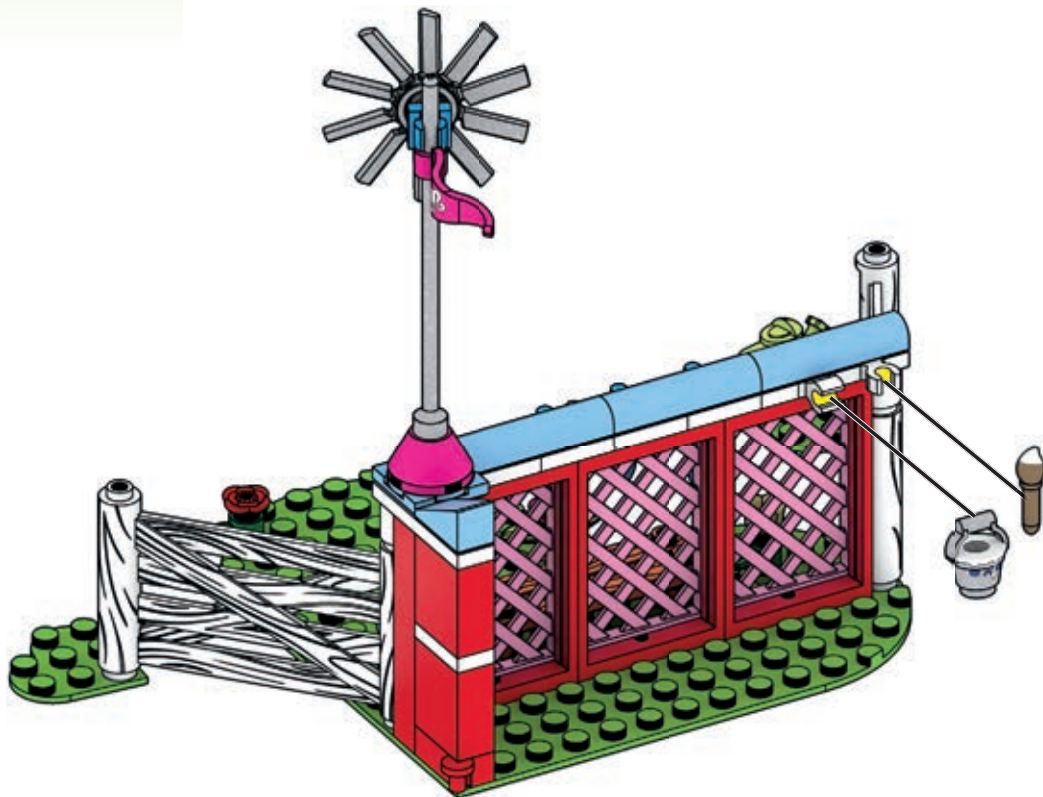



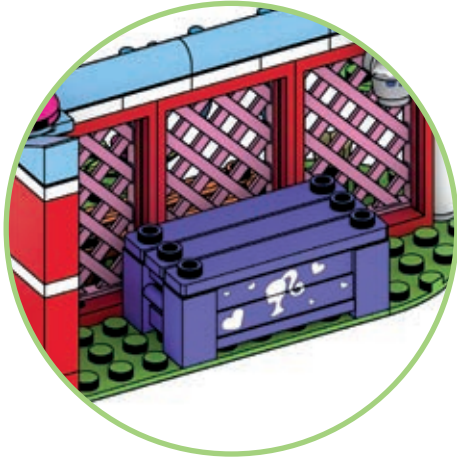
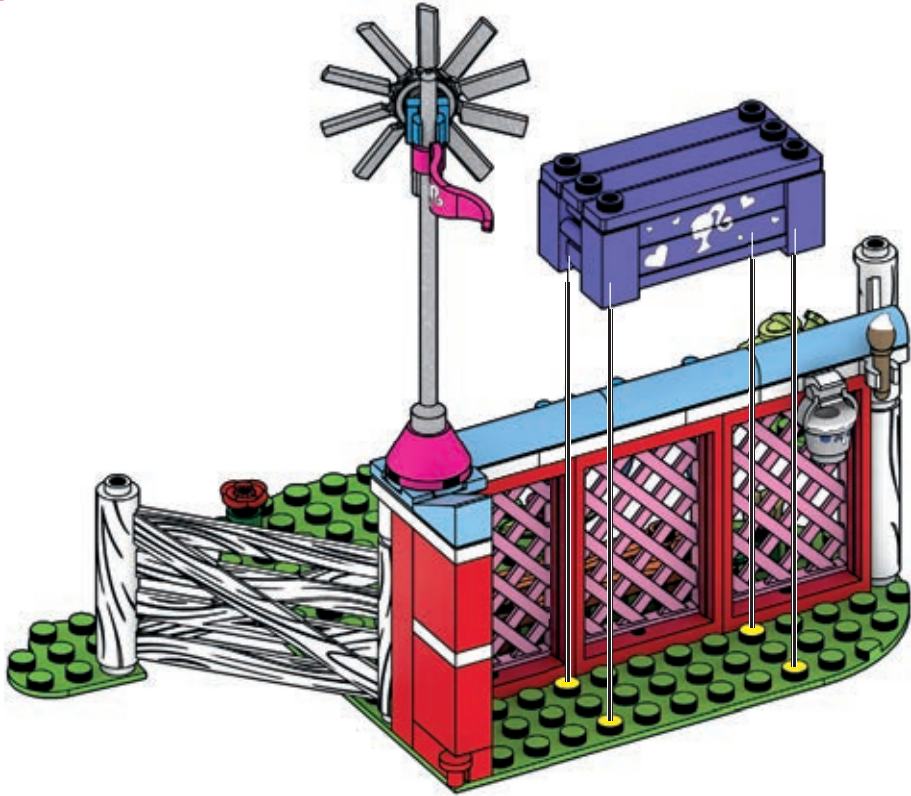



111





113





114

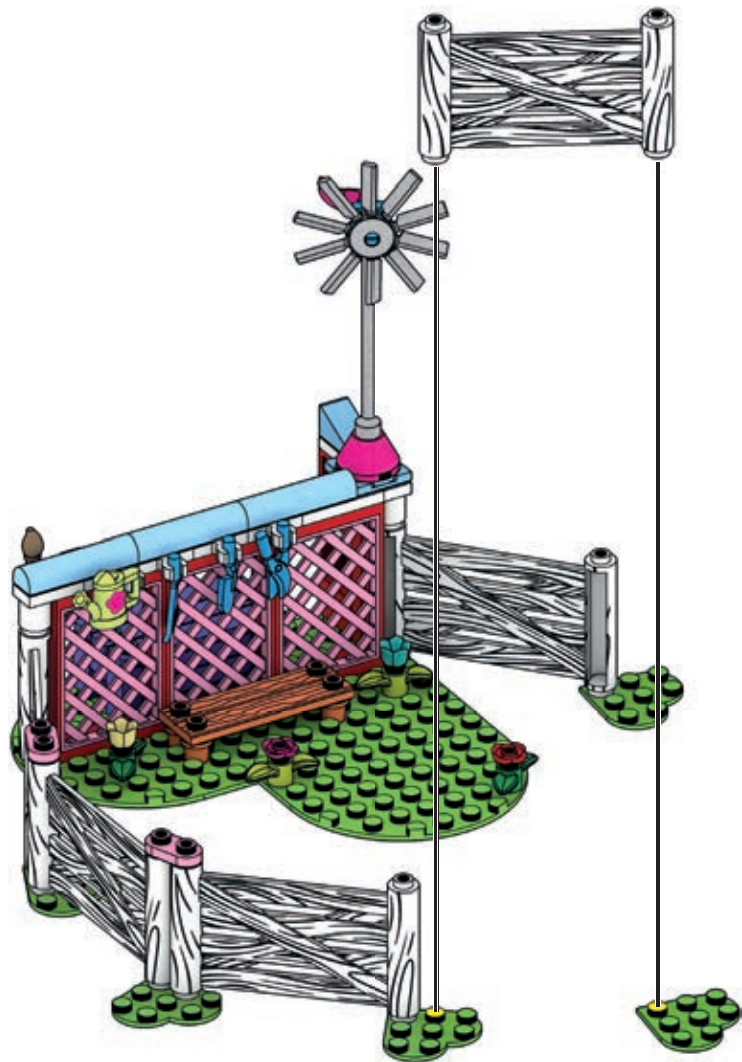
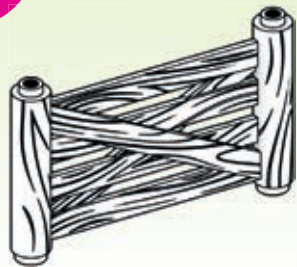

115

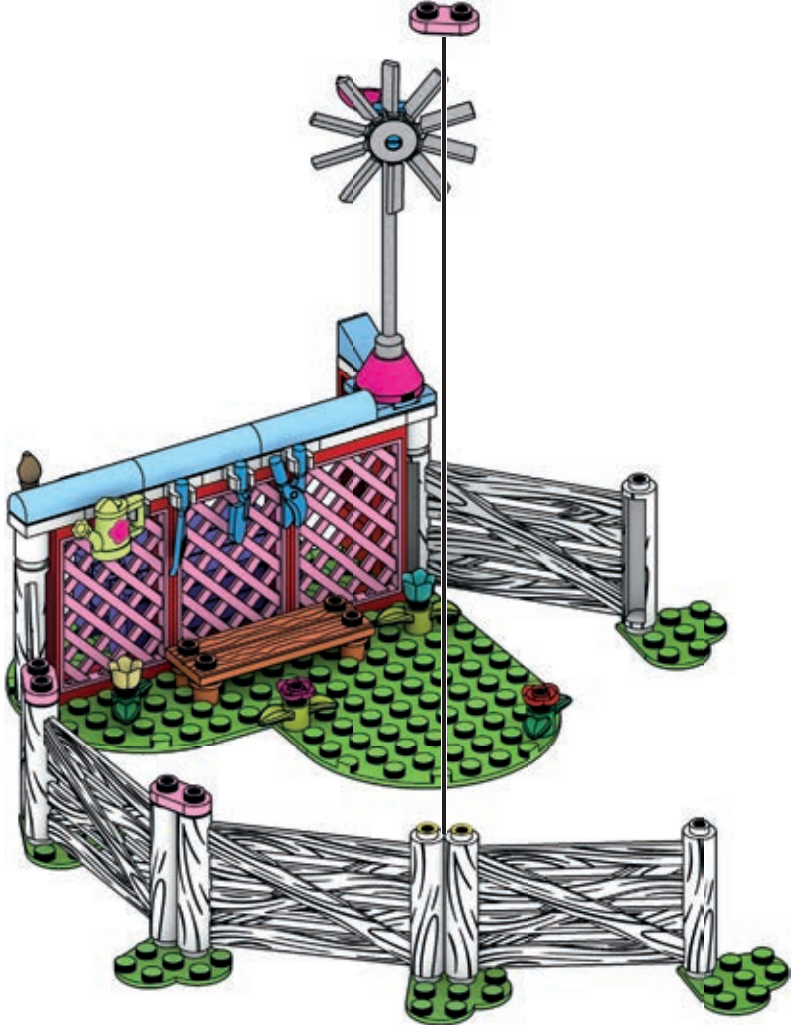

116

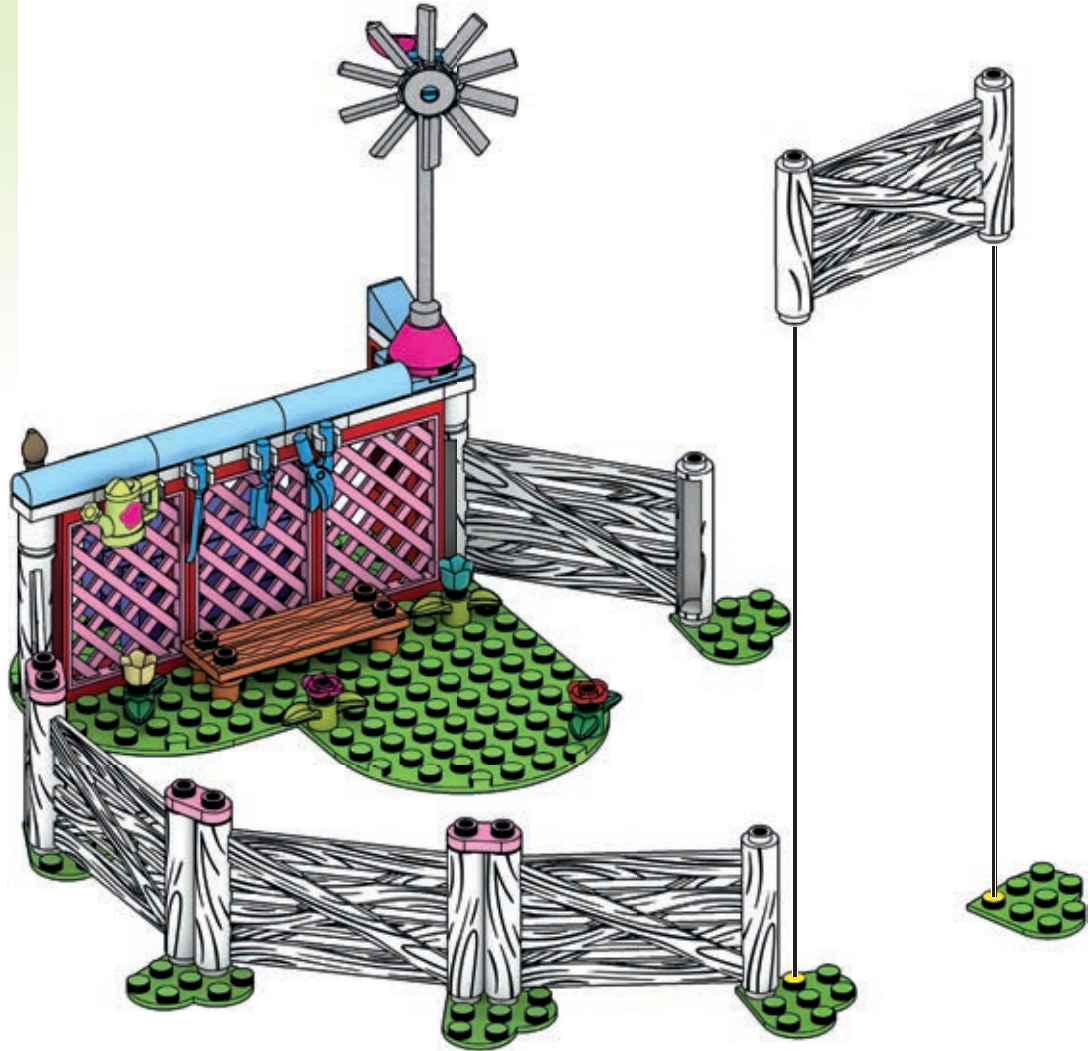
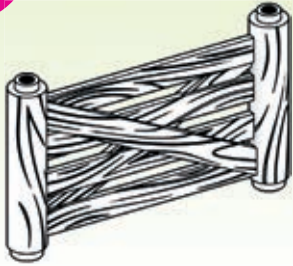

117





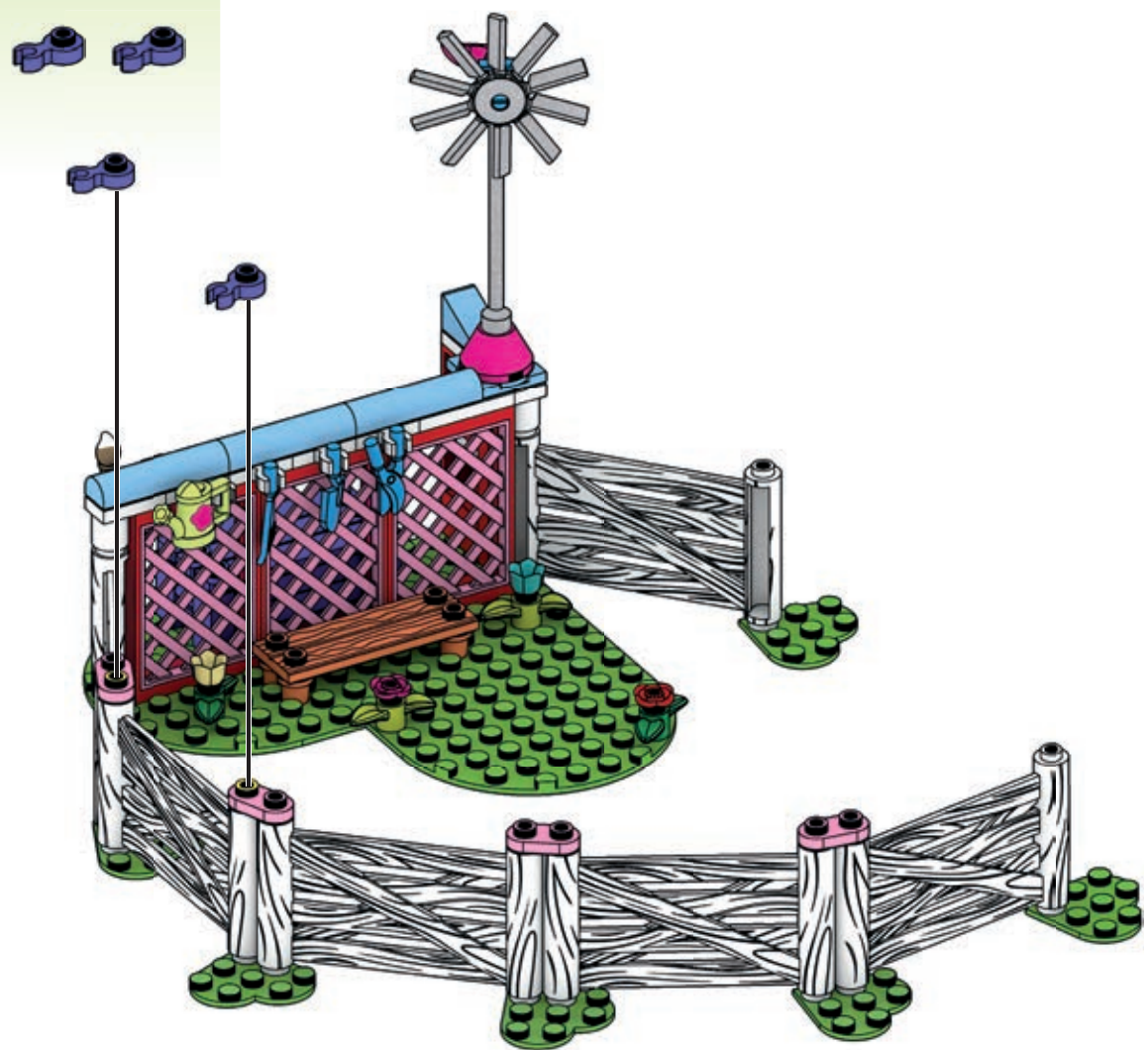



119

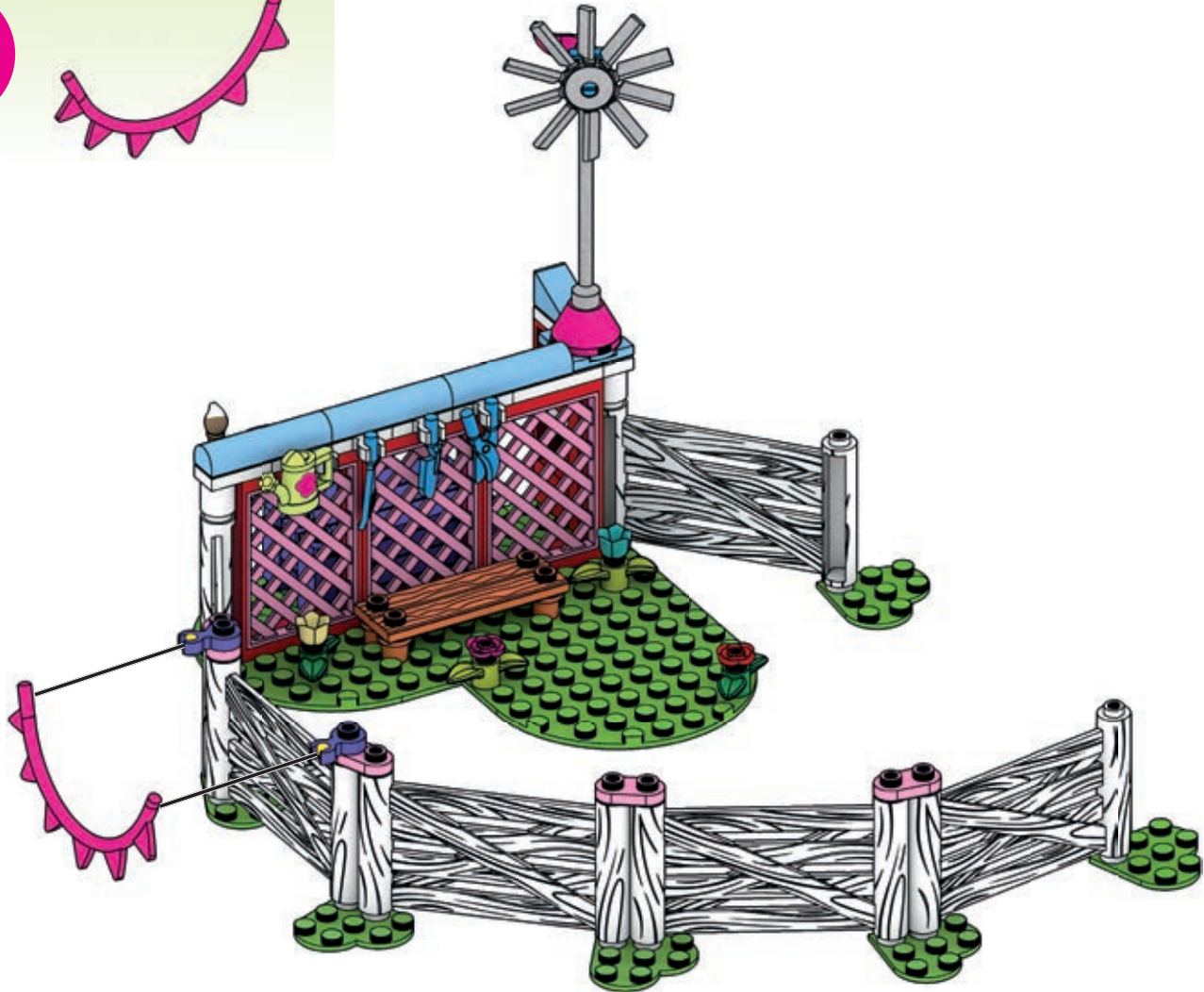

120

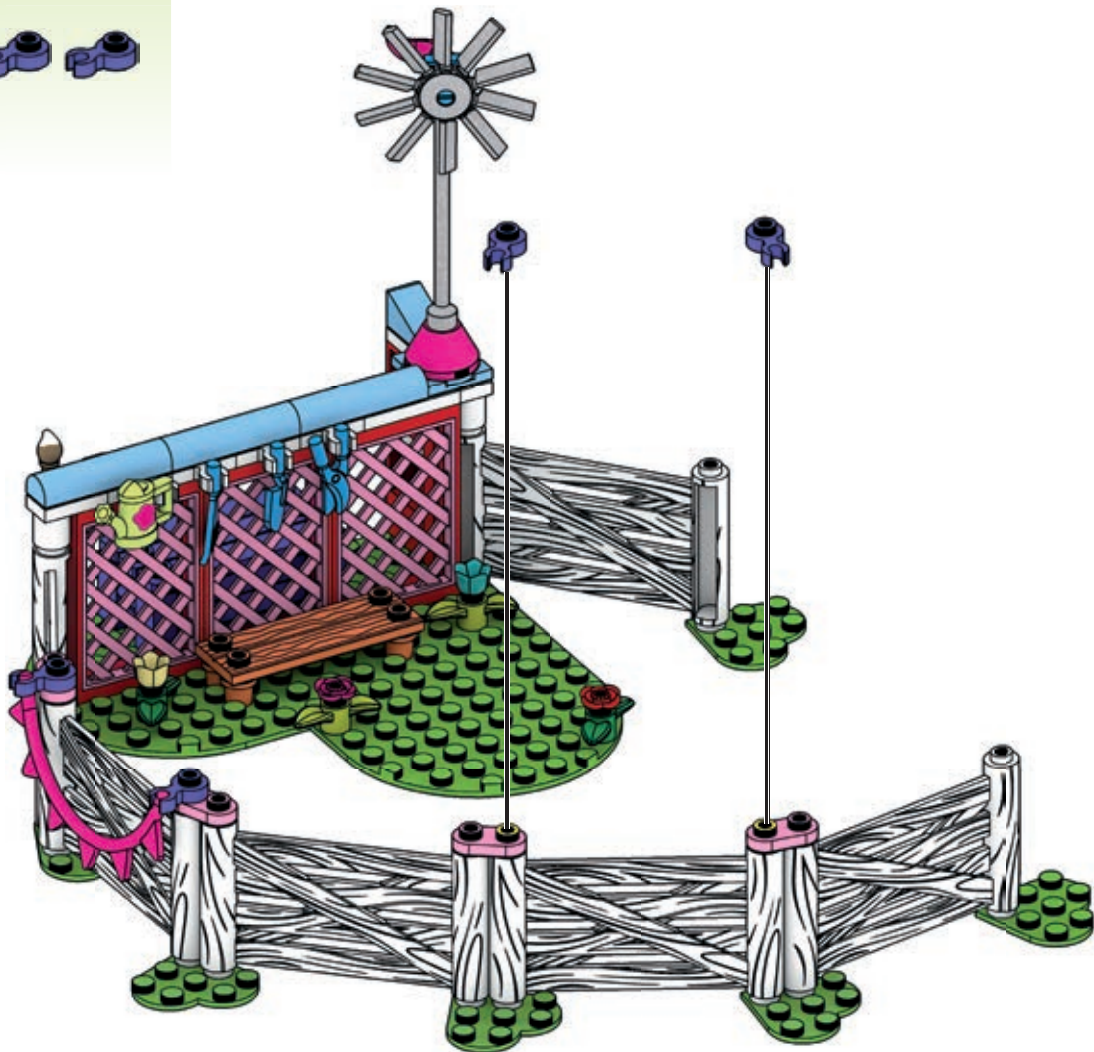

121

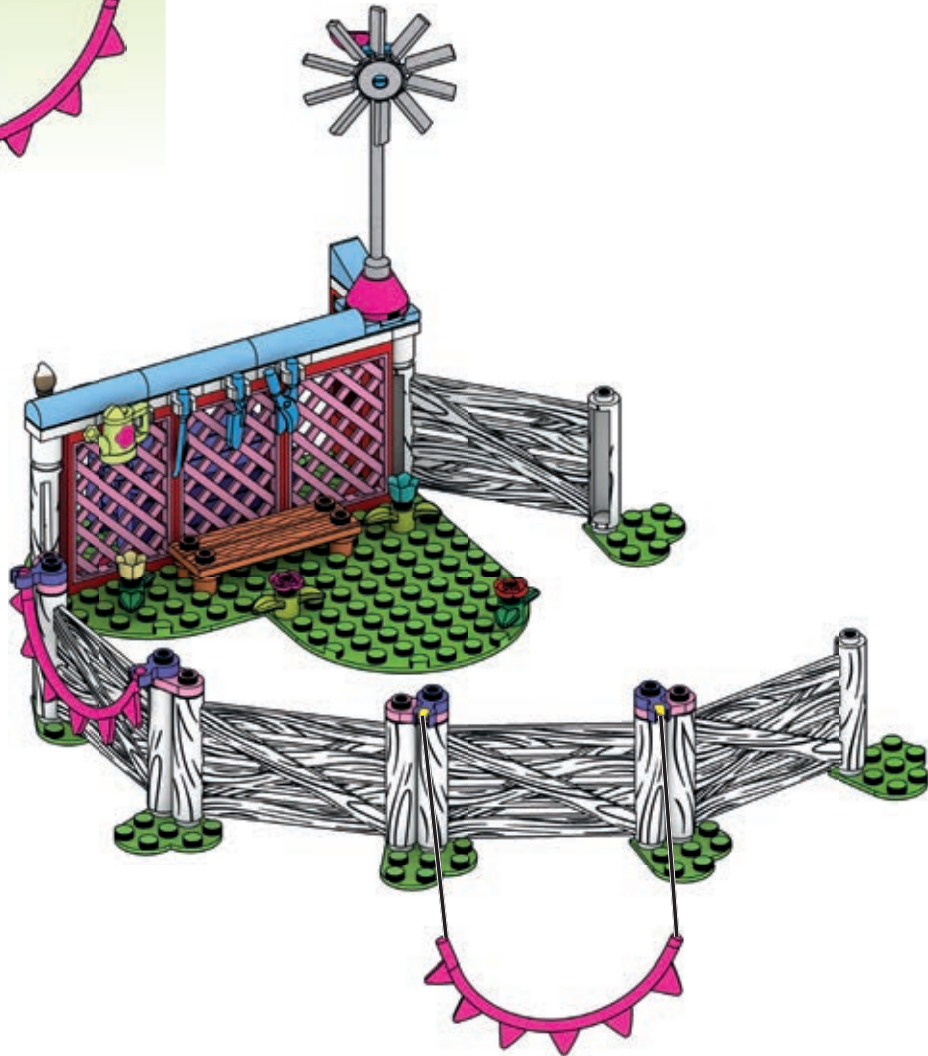

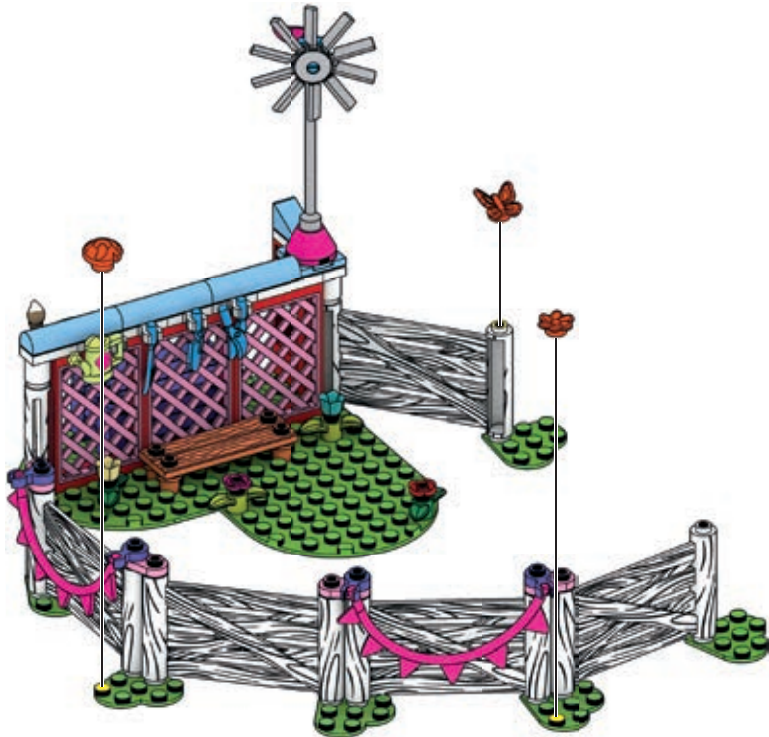

1



2



# LET'S PLAY! AMUSONS-NOUS!

ИЗУГАРИ! • A BRINCARI!  
LASS UNS SPIELEN! • НАЧИНАЕМ ИГРУ!





123

47

75

122

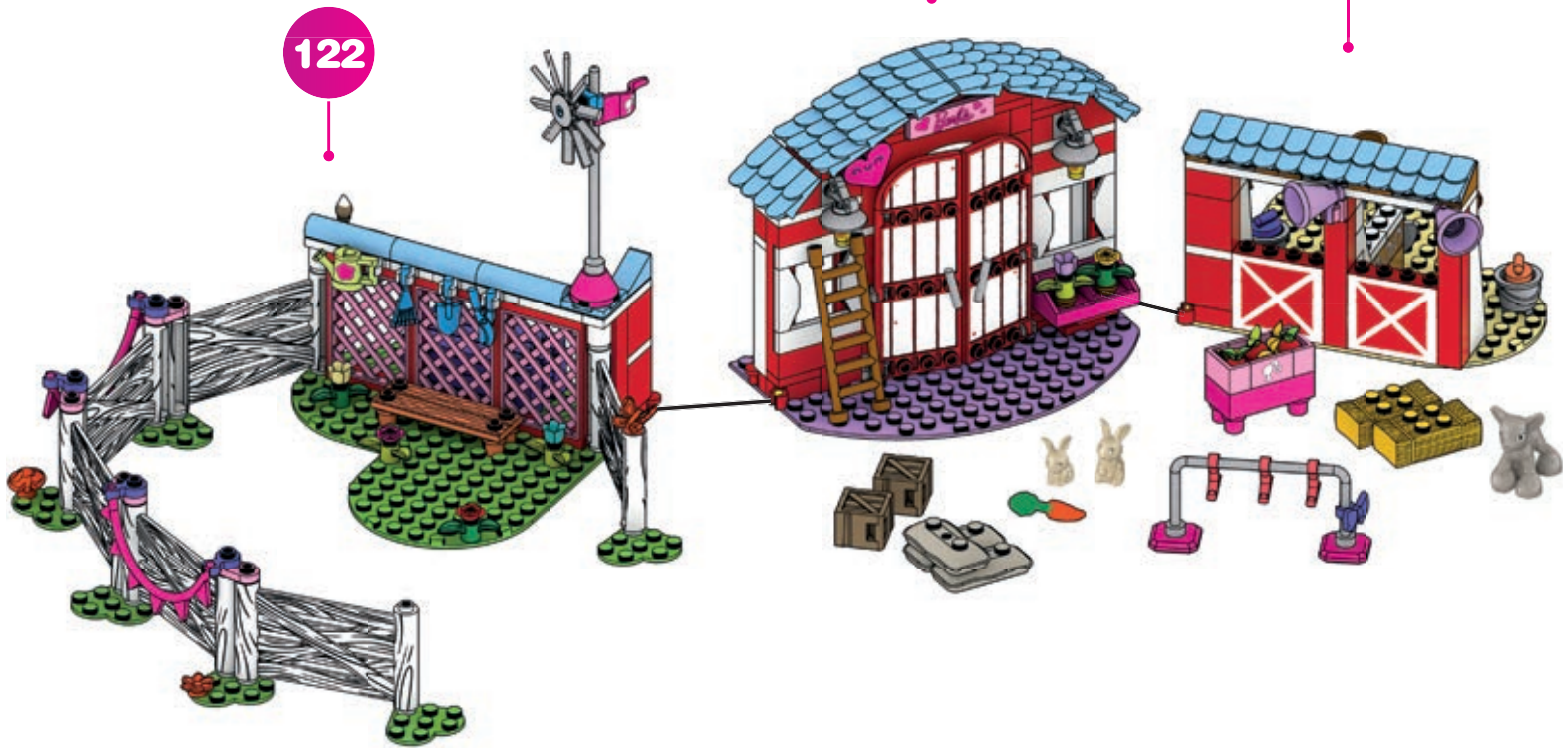

1



2

**FLIP THE BARN & PLAY INSIDE THE STABLES!**  
**RETOURNEZ LA GRANGE ET JOUEZ À L'INTÉRIEUR DE L'ÉCURIE!**

¡DALE LA VUELTA AL GRANERO Y JUEGA EN EL ESTABLO! • VIRA O CELEIRO E BRINCA DENTRO DOS ESTÁBULOS!  
DIE SCHEUNE UMDREHEN UND IN DEN STÄLLEN SPIELEN! • ПЕРЕВЕРНИ КОНЮШНЮ И ИГРАЙ СО СТОЙЛАМИ!







**PLAY OUTSIDE THE STABLES!  
JOUÉZ À L'EXTÉRIEUR DE L'ÉCURIE!**

¡JUEGA FUERA DEL ESTABLO! • BRINCA FORA DOS ESTÁBULOS!  
AUSSERHALB DER STÄLLE SPIELEN! • ИГРАЙ РЯДОМ С КОНЮШНЕЙ!







**COMBINE THE GARDEN AND  
STABLE FOR A HORSE SHOW!  
COMBINEZ LE JARDIN ET  
L'ÉCURIE POUR ORGANISER UN  
SPECTACLE ÉQUESTRE!**

¡COMBINA EL JARDÍN Y LOS ESTABLOS PARA  
UN ESPECTÁCULO DE CABALLOS!  
MISTURE O JARDIM E OS ESTÁBULOS PARA  
UM ESPETÁCULO DE CAVALOS!  
DEN GARTEN UND DIE STÄLLE FÜR EINE  
PFERDE-SHOW KOMBINIEREN!  
ОБЪЕДИНИ САД И КОНЮШНЮ ДЛЯ ВЫСТАВКИ ЛОШАДЕЙ!

1



2



2x  
AM01113MY

3x  
AM78802AMC

1x  
AM78803BBG

3x  
AM78803BYE

2x  
AM78803HT

1x  
AM72954AMC

1x  
AM72954ATC

1x  
AM72954BYE

1x  
AM74648GX

1x  
AM75175MCCX

1x  
AM72953JF

1x  
AM72953CS

1x  
AM72953NL

1x  
AM18623GX

2x  
AM19999ASX

1x  
AM73975AMP

1x  
AM73975AAD

4x  
AM81164AAD

4x  
AM81164ATC

2x  
AM81215ZD

2x  
AM0910E

2x  
AM01086E

1x  
AM01086AMC

3x  
AM07629AMC

3x  
AM07629E

2x  
AM07629APG

1x  
AS-HDJ87-07

1x  
AM75176MCCX

1x  
AM75174MCCX

2x  
AM18287APG

3x  
AM81245RO

1x  
AS-HDJ87-11

1x  
AM73193AMP

1x  
AM77912AWS

1x  
AM77912ATH

1x  
AM77912APG

1x  
AS-HDJ87-14

2x  
AM76026NL

4x  
AM12251AMP

1x  
AM18591E

1x  
AM74415E

2x  
AM76054E

4x  
AM80174ASX

7x  
AM09393E

2x  
AM09393AMC

4x  
AM19660E

2x  
AM74016APG

1x  
AS-HDJ87-10

2x  
AM77226APG

1x  
AM78169AWU

1x  
AS-HDJ87-09

3x  
AM78726BMG

3x  
AM78726BBG

1x  
AS-HDJ87-04

2x  
AM73974APG

1x  
AM01404ATC

4x  
AM80573AMC

3x  
AM76559AMC

3x  
AM76560AMC

1x  
AM04430I

6x  
AM04429MY

1x  
AM07228ASX

1x  
AS-HDJ87-08

2x  
AM81095ASX

2x  
AM09013AMC

1x  
AM72917E

4x  
AM72917APG

4x  
AM15484AMC

2x  
AM73009ATC

5x  
AM03773AMC

1x  
AS-HDJ87-16

1x  
AM18223AMC

6x  
AM81364HT

1x  
AM03772AMC

1x  
AM10931MY

2x  
AM17153AMC

1x  
AM09023AMC

8x  
AM03872AMC

4x  
AM04218AMC

1x  
AM18658E

2x  
AM76777ASE

- 4x AM76450E
- 1x AM78712GX
- 1x AM78710GX
- 1x AM78711GX
- 1x AM01314E
- 1x AS-HDJ87-06
- 1x AM09593E
- 4x AM09838E
- 1x AS-HDJ87-03
- 3x AM79678I
- 3x AM74718DO

- 1x AM19134APG
- 3x AM16289AMC
- 2x AM16289E
- 2x AM03767E

- 1x AM17503AMC
- 3x AM01087AMC
- 1x AM78479APG
- 1x AM09033ATC
- 2x AM09493E
- 1x AM19754ATC
- 2x AM77499BYE

- 11x AM81161I
- 2x AS-HDJ87-05
- 3x AS-HDJ87-17
- 2x AM80908AMC

- 2x AM07475E
- 1x AM79449AAD
- 2x AM17194AMC
- 1x AM01313MY
- 1x AS-HDJ87-12
- 1x AM80741MY
- 1x AM80855MCX

- 1x AM76572AMP
- 1x AS-HDJ87-13
- 1x AM72890AMC
- 1x AM72890E
- 6x AM77227E



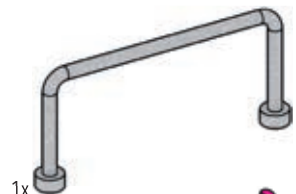

1x  
AM01462APG



2x  
AM81162ATC



1x  
AM09323APG

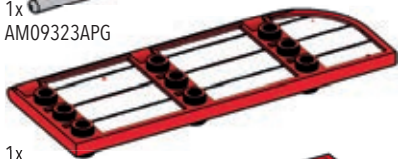

1x  
AS-HDJ87-01

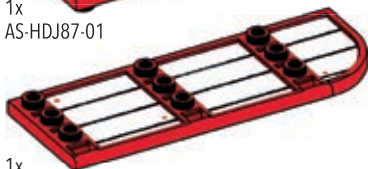

1x  
AS-HDJ87-02



1x  
AM01172E

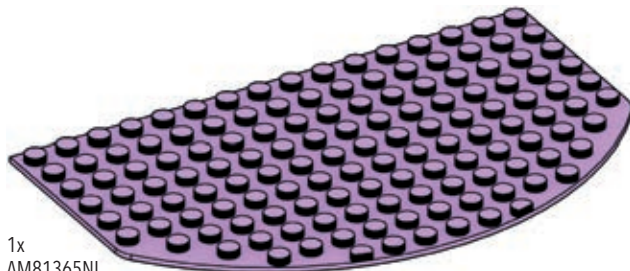

1x  
AM81365NL

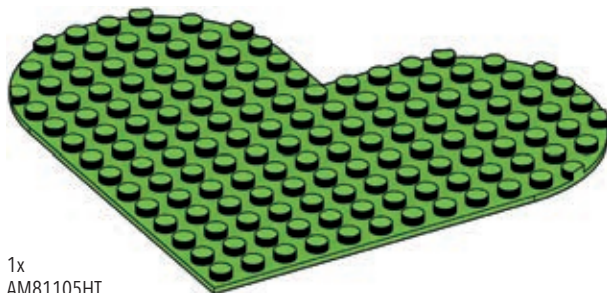

1x  
AM81105HT

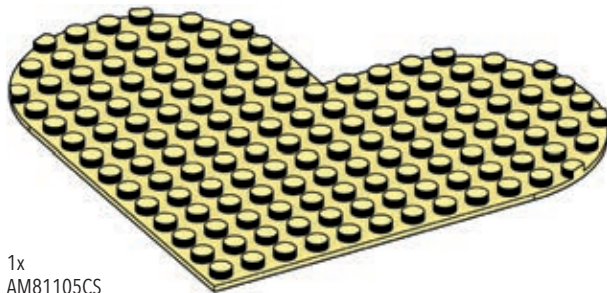

1x  
AM81105CS



1x  
FIG-HDJ87-G



1x  
FIG-HDJ87-E



1x  
FIG-HDJ87-F

1x  
AS-GWR34-D



1x  
AS-GWR34-E



1x  
AS-GWR35-E



1x  
AS-GWR35-D

1x  
AM81371BYE



1x  
AM81129RQ



1x  
AM81369ASV



1x  
AM81369ATS



1x  
AM81121RQ



1x  
AM81120AMP



1x  
AM81370VS



1x  
AM81124ADS



1x  
AM81124DR



1x  
AM81119ASV



1x  
AM81123NL



1x  
AM81123GX



1x  
AM81373ASX

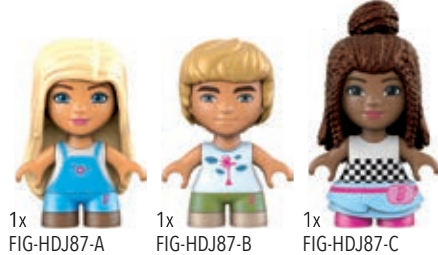

1x  
FIG-HDJ87-A

1x  
FIG-HDJ87-B

1x  
FIG-HDJ87-C



1x  
FIG-HDJ87-D

1x  
FIG-HDJ87-H

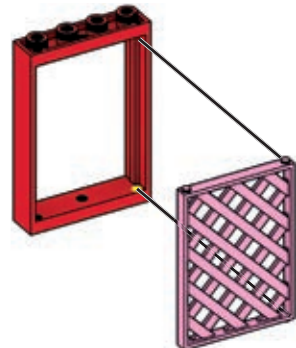

**Missing pieces?  
Pièces manquantes?  
¿Partes faltantes? · Perdeu peças?  
Fehlen Teile? · Не хватает деталей?**

[support.megabrand.com](http://support.megabrand.com)

⚠ WARNING :  
CHOKING HAZARD. - Small parts.  
Toy contains a small ball.  
Not for children under 3 years.

⚠ ATTENTION :  
DANGER D'ÉTOUFFEMENT. - Présence de petits éléments.  
Le jouet contient une petite balle.  
Ne convient pas aux enfants de moins de 3 ans.

⚠ 警告:  
のどにつまる危険 小さな部品が含まれています  
小さな玉が含まれています。  
3歳以下の子供には与えないで下さい。

⚠ تحذير:  
خطر الاختناق - قطع صغيرة  
تحتوي اللعبة على كرة صغيرة  
غير صالحة للأطفال أقل من 3 سنوات

⚠ 警告!  
噎住危險。包含有小部件  
此玩具含有一个小球。  
不适合3岁以下的小孩玩。

ADVERTENCIA: PELIGRO DE ATRAGANTAMIENTO. Juguete no recomendado para menores de 3 años, porque contiene piezas pequeñas / bolitas que podrían provocar asfixia en caso de ser ingeridas o inhaladas por el/la niño/a.

ATENÇÃO! Não indicado / não recomendável para crianças menores de 3 (três) anos por conter parte(s) pequena(s) / bola(s) pequena(s) que pode(m) ser engolidas(o) ou aspirada(s) podendo provocar asfixia.

AVVERTENZA: Piccole parti. Piccole palle. Rischio di soffocamento.

ACHTUNG: Kleine Teile. Kleine Kugeln. Erstickungsgefahr.

OSTRZEŻENIE: Małe części. Małe kulki. Niebezpieczeństwo zadławienia.

WAARSCHUWING: Kleine onderdelen. Kleine balletjes. Verstikkingsgevaar.

ПРЕДУПРЕЖДЕНИЕ: Мелкие детали. Маленькие шарики. Опасность проглатывания.

ADVARSEL: Små dele. Små bolde/kugler. Kvælningsfare.

WARNING: Smådelar. Små bollar. Kvävningsrisk.

ADVARSEL: Små deler. Små kuler. Kvælningsfare.

VAROITUS: Pieniä osia. Pieniä palloja. Tukehtumisvaara

ΠΡΟΣΟΧΗ: Μικρά κομμάτια. Μικρές μπιλιτσές. Κίνδυνος Πνιγμού.

UYARI: Küçük parçalar. Küçük toplar. Yutma tehlikesi.

UPOZORNENIE: Malé diely. Malé micky. Nebezpečie udúšenia.

UPOZORNENIE: Malé casti. Malé guľôčky. Nebezpečenstvo zadusenia.

FIGYELMEZTETÉS: Kis alkatrészek. Kis labdák. Fulladásveszély.



Mattel Europa B.V., Gondel 1, 1186 MJ Amstelveen, Nederland. Mattel U.K. Limited, The Porter Building, 1 Brunel Way, Slough SL1 1FO, UK. Mattel France, Parc de la Cerisaie, 1/3/5 allée des Fleurs, 94260 Fresnes Cedex. N° Cristal 0969 36 99 99 (Numero non surtaxé) ou www.lesjouetsmattel.fr Mattel Belgium, Trade Mart, Atomiumsquare, Bogota 202 - B 275, 1020 Brussels. Gratis nummer België: 0800 - 16 936 - Gratis nummer Luxemburg: 800 - 22 784 - Gratis nummer Nederland: 0800 - 262 88 35. Deutschland: Mattel GmbH, Solmsstraße 4, D-60486 Frankfurt am Main, Schweiz: Mattel AG, Kirchstrasse 24, CH-3097 Liebefeld. Österreich: Mattel Ges.m.b.H., Campus 21, Liebermannstraße A01 404, A- 2345 Brunn/Gebrige, Mattel Italy Srl, Via Bracco, 6-MAC 6, 20159 Milano, Italy. Servizio assistenza clienti: Customerservizioitalia@mattel.com - Numero verde 800 11 37 11. Mattel España, S.A., Aribau 200, 08036 Barcelona, cservice.spain@mattel.com; Tel: 900 102 390 http://www.service.mattel.com/es. Mattel East Asia Ltd., Room 503-09, North Tower, World Finance Centre, Harbour City, Tsimshatsui, HK, China. Tel.: (852) 3185-6500. Diimport & Diedarkan Oleh: Mattel Continental Asia Sdn Bhd. Level 19, Tower 3, Avenue 7, No. 8 Jalan Kerinchi, Bangsar South, 59200 Kuala Lumpur, Malaysia. Mattel South Africa (PTY) LTD, Office 10213, 30 Melrose Boulevard, Johannesburg 2196, Dysturbuytor: Mattel Poland Sp. z o.o., Warsaw Trade Tower 34 p., ul. Chłodna 51, 00-867 Warszawa. Mattel Australia Pty. Ltd., 658 Church St., Richmond, Victoria, 3121, Consumer Advisory Service - 1300 135 312. Mattel AEBE, Εβδούρου Μακαρίου 1, Κτήριο Κ-2, ΤΚ 17561, Ποσειδά Φόρλορ. Mattel Ouncacalkil Tic. Ltd. Sti. Jerekenku Mah., Erkut Sok. A Blok No:12 Üner Plaza Kat:9-10 34752 Ataşehir İstanbul. Tel: 0216 570 75 00. Импортёр/Уполномоченная организация: ООО "МАТТЕЛ" Российская Федерация, 105120 Москва, 2-й Сыромятинский переулок 1; +7 495 287 79 39. Mattel Czech Republic s.r.o., The Forum, Václavské nám. 19, 11000 Praha1, Mattel, 333 Continental Boulevard, El Segundo, CA 90245, USA. Consumer Services: 1-800-465-MEGA (6342). Importado y distribuido por Mattel de México, S.A. de C.V., Miguel de Cervantes Saavedra No. 193, Pisos 10 y 11, Col. Granada, Alcatlita Miguel Hidalgo, C.P. 11520, México, Ciudad de México. R.F.C. MME-920701-NB3. Tels: 59-05-51-00 Ext. 5206 ó 01-800-463-59-89. Mattel Chile, S.A., Avenida América Despucio 501-B, Quilicura, Santiago, Chile. Tel: 01800-710-2069. Mattel Perú, S.A., Av. Juan de Arona # 151, Centro Empresarial Juan de Arona, Torre C, Piso 7, Oficina 704, San Isidro, Lima 27, Perú. RUC: 20425853865. Reg. Importador: 02350-12-JUE-DIGESA. Tel: 0800-54744. E-mail Latinoamérica: servicio.clientes@mattel.com. Mattel do Brasil Ltda. - CNPJ : 54.558.002/0001-20 - Rua Verbo Divino, 1488 - 2º Andar - 04719-904 - Chácara Santo Antônio - São Paulo - SP - Brasil. Serviço de Atendimento ao Consumidor: fone 0800 575 0780. E-mail: sac.matteldobrazil@mattel.com





CONJUNTOS DE CONSTRUÇÃO  
BAUSETS • НАБОРЫ КОНСТРУКТОРОВ



HDJ84



HDJ85

MORE TO COLLECT!

ENCORE PLUS À COLLECTIONNER !

IMÁS PARA COLECCIONARI! • MAIS PARA COLECIONAR!  
MEHR ZUM SAMMELN! • СОБЕРИ БОЛЬШЕ!



HDJ84



HDJ85

Set(s) sold separately and subject to availability. / Ensemble(s) vendu(s) séparément. Certains produits peuvent ne pas être commercialisés. / Se vende(n) por separado y está(n) sujeto(s) a disponibilidad. / Conjunto(s) vendido(s) em separado e sujeito(s) à disponibilidade. / Set in vendita separatamente, secondo disponibilità. / Das/Die Set(s) sind separat erhältlich. / Zestaw(y) sprzedawany(e) oddzielnie w zależności od dostępności. / Set(s) apart verkrijgbaar en afhankelijk van beschikbaarheid. / Набор(-ы) продаются отдельно, при наличии. / Sæt sælges separat og så længe lager haves. / Seten säljs separat så länge lagret räcker. / Settet/settene selges separat så langt lageret rekker. / Pakkaus/pakkaukset myydään erikseen, saatavuus voi vaihdella. / Το(α) σετ πωλούνται ξεχωριστά και ανάλογα με τη διαθεσιμότητα. / Setler ayrı olarak satılır ve stoklarla sınırlıdır. / Set (sety) se prodává (prodávají) samostatně dle aktuální nabídky. / Súprava/-y sa predáva(jú) samostatne a podľa dostupnosti. / A készlet(ek) külön kapható(k), az elérhetőség változhat. / セット商品は別売りになります。在庫状況は別途ご確認ください。 / تُباع المجموعة أو المجموعات على حدة وتخضع لتوافرها.

每套单独发售，按供货情况决定。

HORSE STABLES | LES ÉCURIES | PFERDESTÄLLE | SCUDERIE | PAARDENSTALLEN | ESTABLOS DE CABALLOS | ESTÁBULOS DE CAVALOS | HÄSTSTALL | HORSE STABLES | HESTESTALD | HESTESTALLER | STAJNIA STAJE | KÖNSKÉ STAJNE | ISTÁLLÓK | КОНОШНЯ | ΣΤΑΒΛΟΣ ΜΕΛΛΟΤΑ | AT AHIRI | اسطبلات الخيل

©2021 MEGA Brands &™ MEGA Brands. BARBIE® and associated trademarks and trade dress are owned by and used under license from Mattel. BARBIE ainsi que les marques et designs y afférents appartiennent à, et sont utilisés sous licence de Mattel.

©2021 Mattel.

Printed in China / Imprimé en Chine

AD-HDJ87-01

1186 MJ, 1, NL

Mattel Canada Inc. Mississauga, Ontario L5R 3W2.

MADE IN CHINA. FABRIQUE EN CHINE. FABRICADO NA / HECHO EN CHINA.

ИЗГОТОВЛЕНО В КИТАЕ. ÇIN'DE ÜRETİLMİŞTİR. صنع في الصين

UK  
CA

