

fisher-price

Little People®



HCF61

Little DreamHouse™

Before You Begin



Keep these instructions for future reference as they contain important information.



Adult assembly is required (because we need to fit this toy in the box). You'll need a Phillips screwdriver (not included) for assembly and battery installation.



30

Set aside about 30 minutes for assembly.

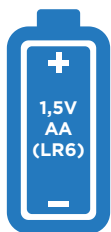

x3

Three AA (LR6) batteries are required (not included). For longer life, use **alkaline** batteries.



Clean with a damp cloth.

Do not immerse.



Do not add water to pool. Pool is not designed to hold water.

Assembled Parts

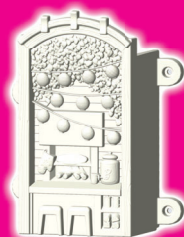
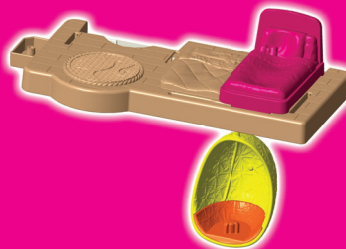
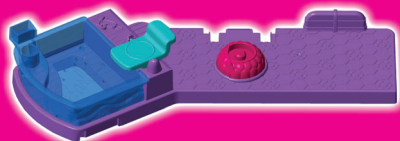
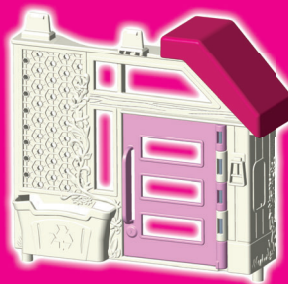
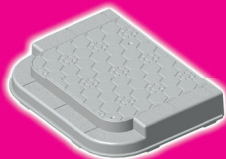
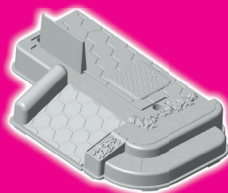
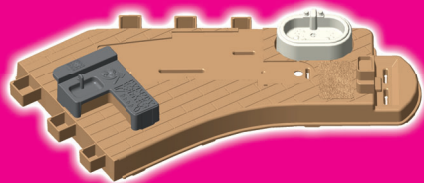

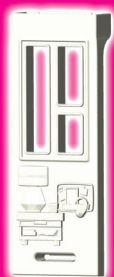
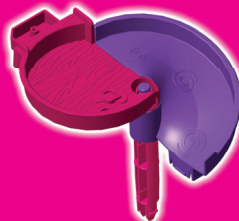
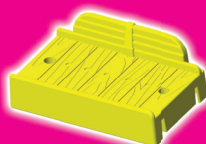
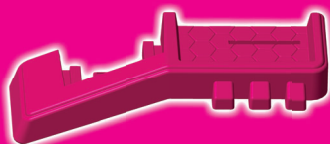
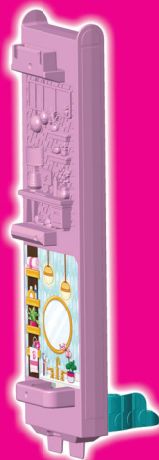

M3,5 x 12 mm



CAUTION

This package contains sharp points and small parts. For adult assembly only.

Assembly

1.

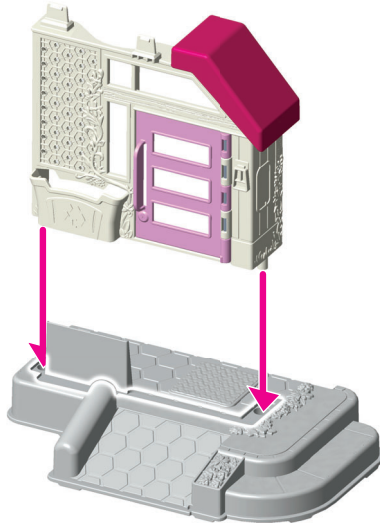

2.

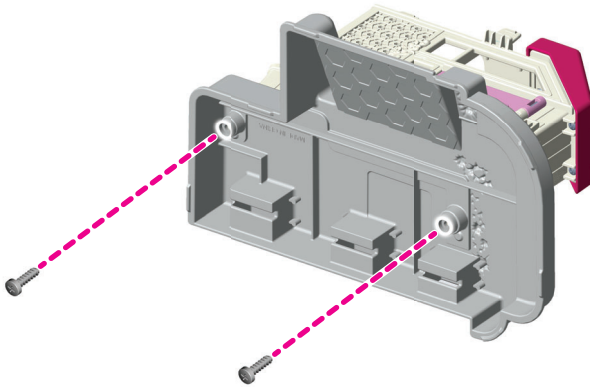

3.

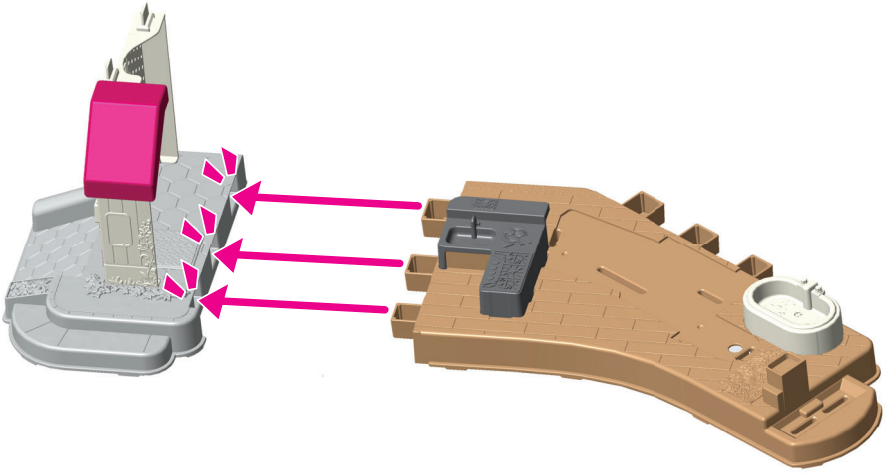

4.

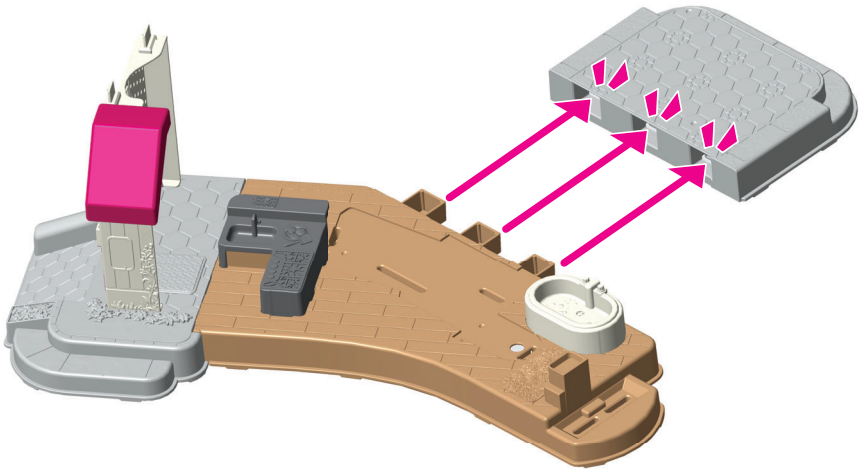

5.

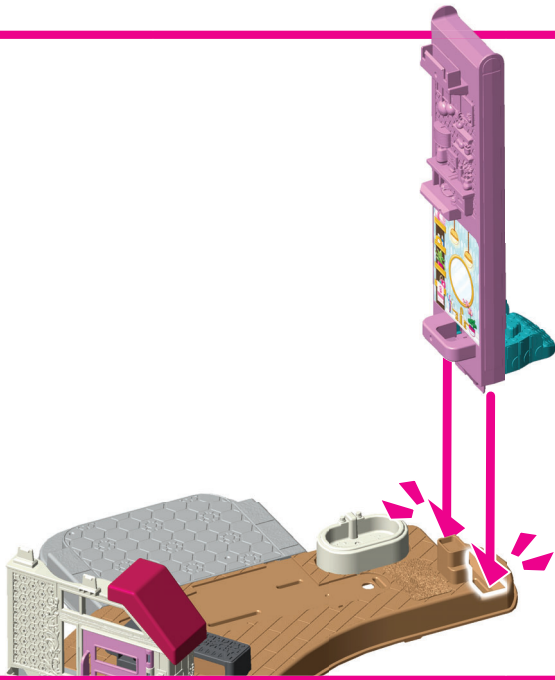

6.

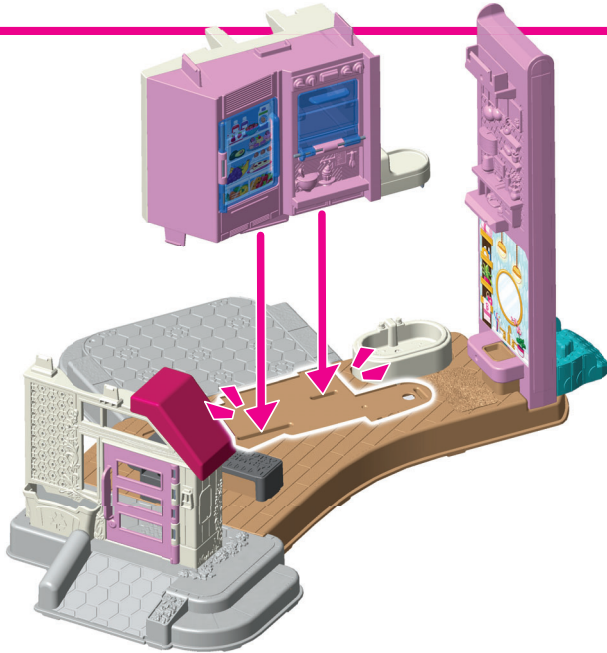

7.

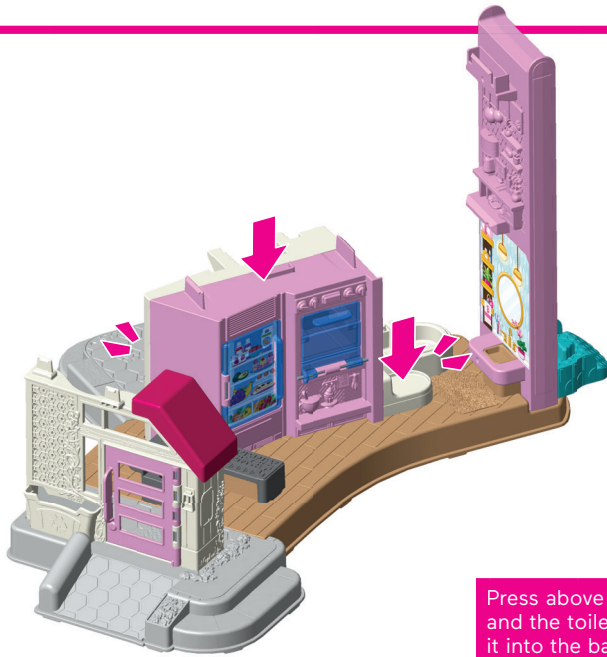

Press above the kitchen and the toilet to "snap" it into the base.

8.

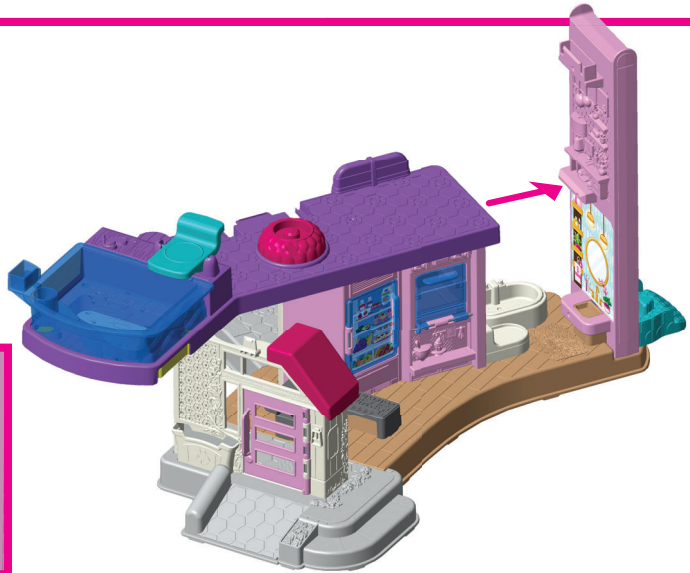

Fit the opening on the platform to the ledge on the wall

9.

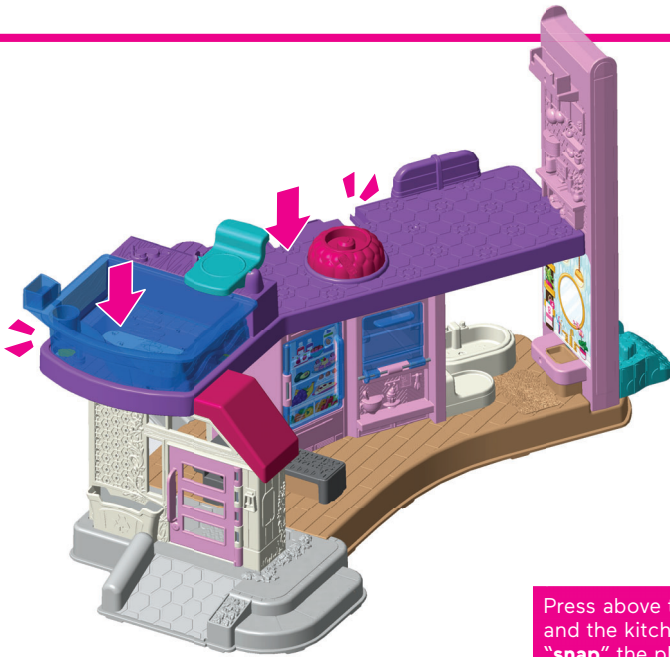

Press above the pool and the kitchen to “snap” the platform.

10.

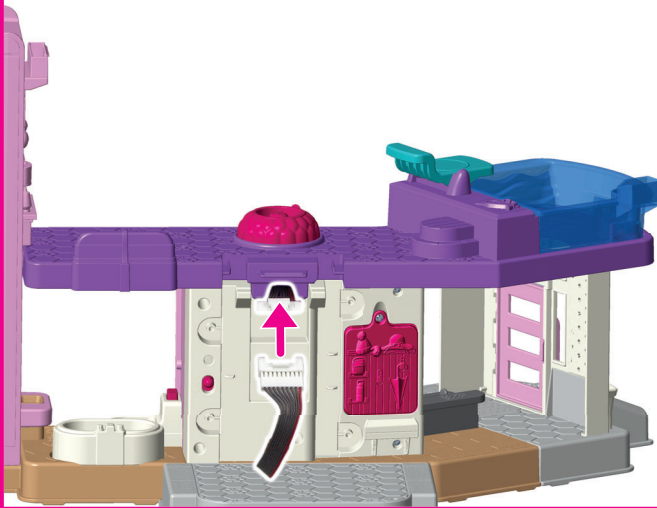

Be sure to make this connection!

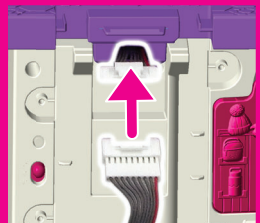



Locate the battery door on the back of the kitchen.
Loosen the screw in the battery door and remove the door.
Insert three, new AA (LR6) **alkaline** batteries. Make sure you insert the batteries correctly!
Replace the battery door and tighten the screw.



Slide the power-volume switch ON . You should hear sound and see lights.
If you do not, you may not have connected the wires in step 10.
Go back and be sure you've connected the wires in step 10.

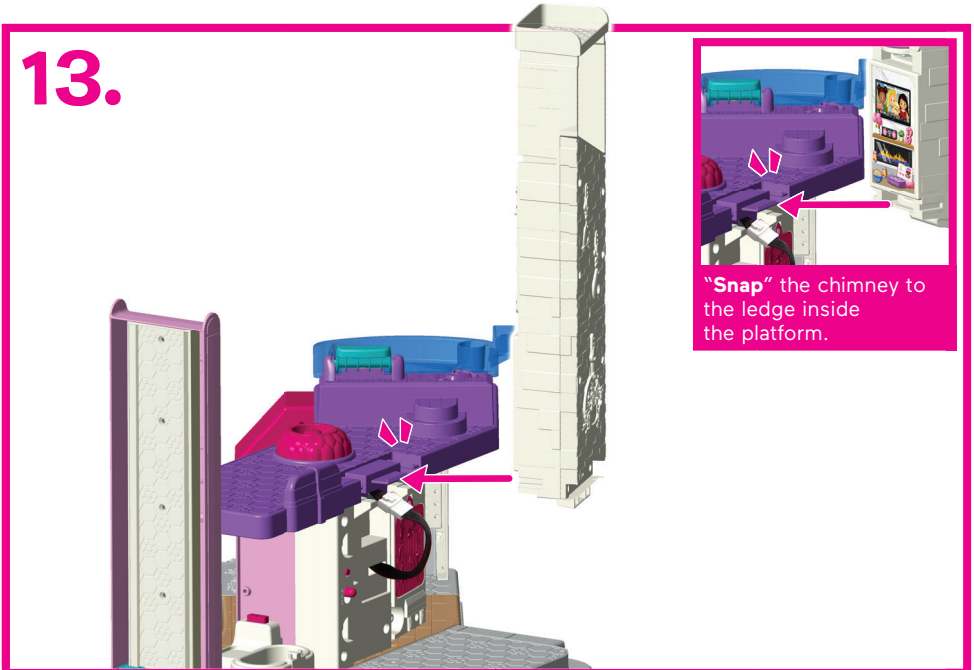

"Snap" the chimney to the ledge inside the platform.

14.

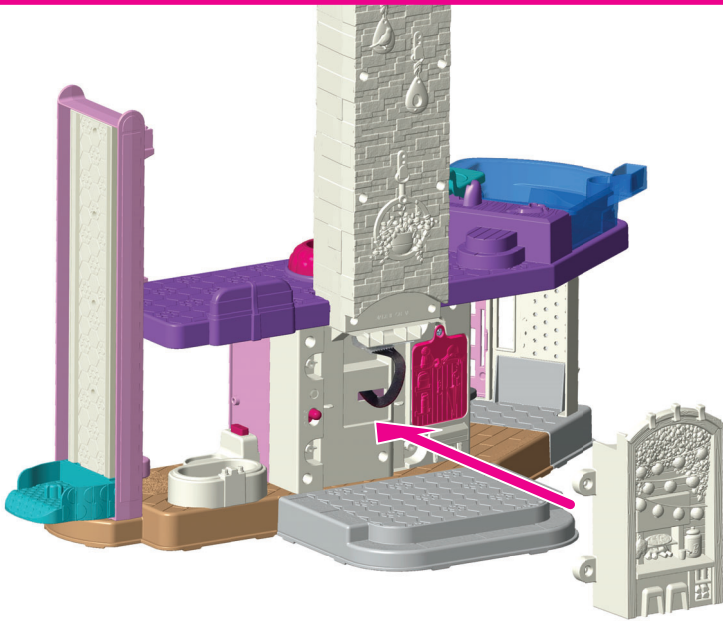

15.

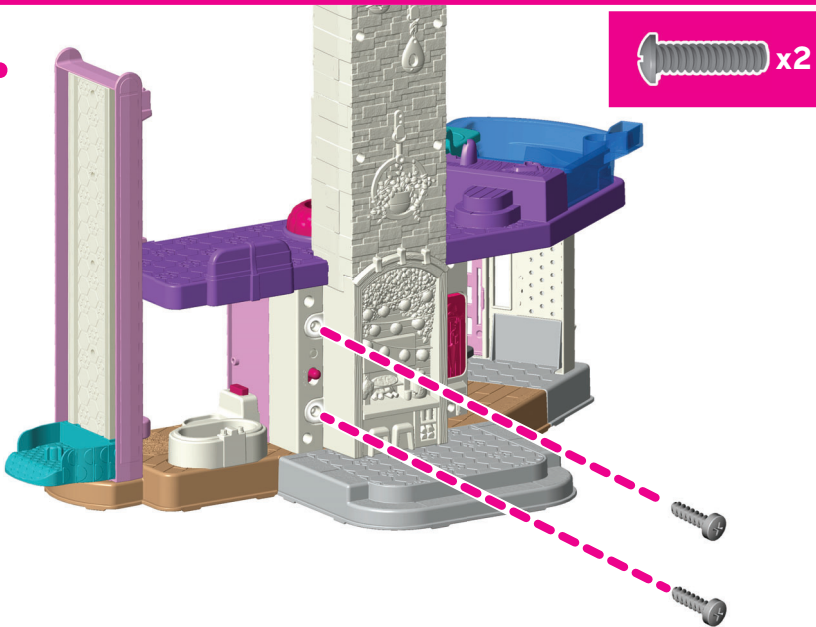

16.

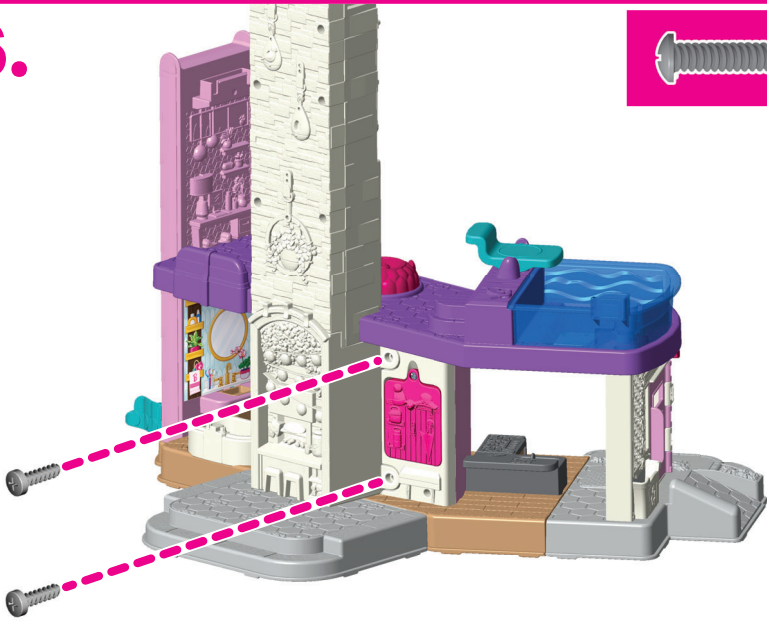

 x2

17.

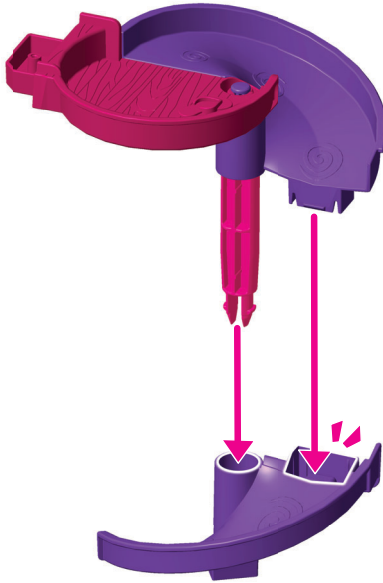

18.



You may need to rotate the slide post to "snap" it. Use the box snap behind the post and on the pool as a guide.

19.



20.

Press to "snap" the platform to the elevator wall.



21.

 x2



22.



23.

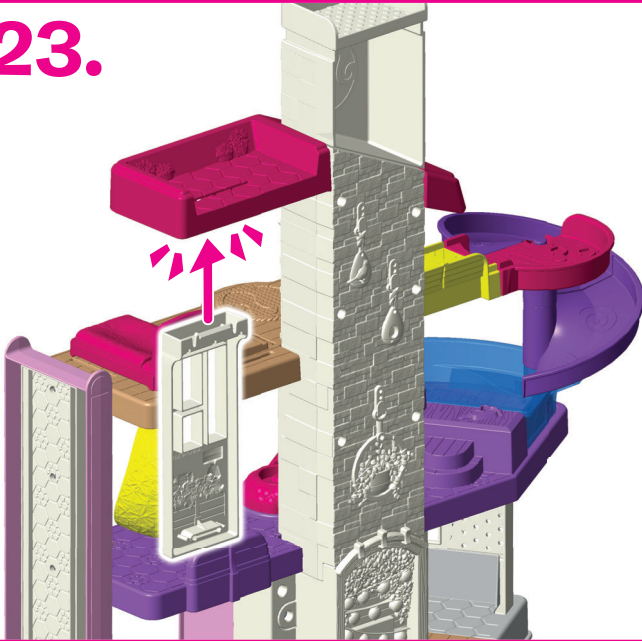

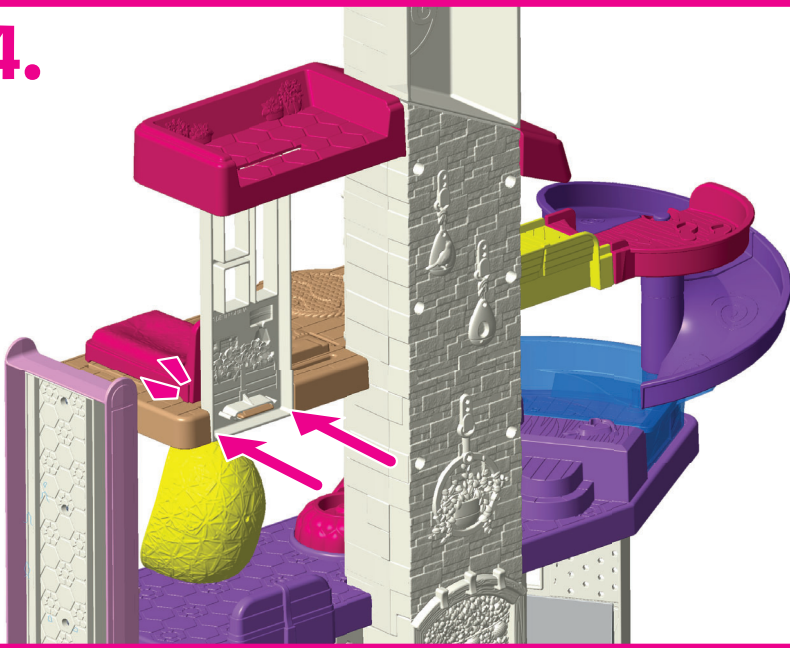

"Snap" the window into the opening underneath the roof.

24.





POWER-VOLUME SWITCH

Slide to turn power ON with low volume , ON with high volume  or OFF  when finished playing.

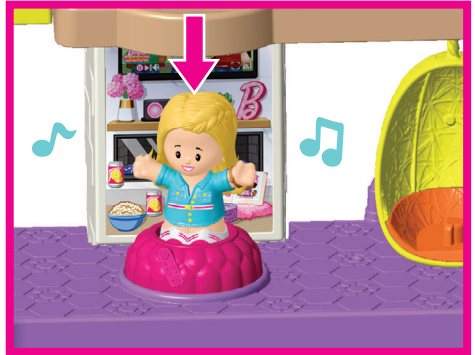

Battery Safety Information

In exceptional circumstances, batteries may leak fluids that can cause a chemical burn injury or ruin your product. To avoid battery leakage:

- Do not mix old and new batteries or batteries of different types: alkaline, standard (carbon-zinc) or rechargeable.
- Insert batteries as indicated inside the battery compartment (+ and -).
- Remove batteries during long periods of non-use. Always remove exhausted batteries from the product. Dispose of batteries safely. Do not dispose of this product in a fire. The batteries inside may explode or leak.
- Never short-circuit the battery terminals.
- Use only batteries of the same or equivalent type, as recommended.
- Do not charge non-rechargeable batteries.
- Remove rechargeable batteries from the product before charging.
- If removable, rechargeable batteries are used, they are only to be charged under adult supervision.

FCC STATEMENT (UNITED STATES ONLY)

This equipment has been tested and found to comply with the limits for a Class B digital device, pursuant to Part 15 of the FCC rules. These limits are designed to provide reasonable protection against harmful interference in a residential installation. This equipment generates uses and can radiate radio frequency energy and, if not installed and used in accordance with the instructions, may cause harmful interference to radio communications. However, there is no guarantee that interference will not occur in a particular installation. If this equipment does cause harmful interference to radio or television reception, which can be determined by turning the equipment off and on, the user is encouraged to try to correct the interference by one or more of the following measures:

- Reorient or relocate the receiving antenna.
- Increase the separation between the equipment and receiver.
- Consult the dealer or an experienced radio/TV technician for help.

NOTE: Changes or modifications not expressly approved by the manufacturer responsible for compliance could void the user's authority to operate the equipment. This device complies with Part 15 of the FCC Rules. Operation is subject to the following two conditions: (1) This device may not cause harmful interference, and (2) this device must accept any interference received, including interference that may cause undesired operation.

CAN ICES-3 (B)/NMB-3 (B)

Operation is subject to the following two conditions: (1) this device may not cause interference, and (2) this device must accept any interference, including interference that may cause undesired operation of the device.

L'utilisation de ce dispositif est autorisée seulement aux conditions suivantes : (1) il ne doit pas produire de brouillage et (2) il doit pouvoir tolérer tout brouillage radioélectrique reçu, même si ce brouillage est susceptible de compromettre son fonctionnement.



Protect the environment by not disposing of this product or any batteries with household waste. This symbol indicates that this product shall not be treated as household waste. Check your local authority for recycling advice and facilities.

**UNITED STATES**

Fisher-Price, Inc., 636 Girard Avenue, East Aurora, NY 14052. Consumer Services: 1-800-432-5437.

CANADA

Mattel Canada Inc., 6155 Freemont Blvd., Mississauga, Ontario L5R 3W2 Consumer Services/Service à la clientèle : 1-800-432-5437. www.service.mattel.com.

GREAT BRITAIN

Mattel U.K. Limited, The Porter Building, 1 Brunel Way, Slough SL1 1FQ, UK. www.service.mattel.com/uk.

NEDERLAND

Mattel Europa B.V., Gondel 1, 1186 MJ Amstelveen, Nederland.

AUSTRALIA

Mattel Australia Pty. Ltd., 658 Church Street, Locked Bag #870, Richmond, Victoria 3121 Australia. Consumer Advisory Service 1300 135 312.

NEW ZEALAND

16-18 William Pickering Drive, Albany 1331, Auckland.

SOUTH AFRICA

Mattel South Africa (PTY) LTD, Office 102 I3, 30 Melrose Boulevard, Johannesburg 2196.

fisher-price®

LittlePeople®

Barbie®

Barbie® and associated trademarks
and trade dress are owned by,
and used under license from Mattel.



©2021 Mattel.
PRINTED IN CHINA

HCF61-0970
1102755439-DOM